



Hürner Luft- und Umwelttechnik

Progressive. Reliable. Measurable.



Plastic fans
and components

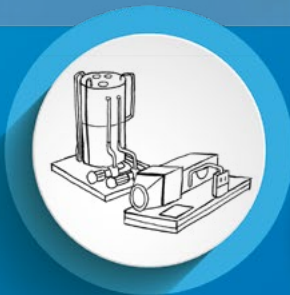

Plastic equipment
and system
construction

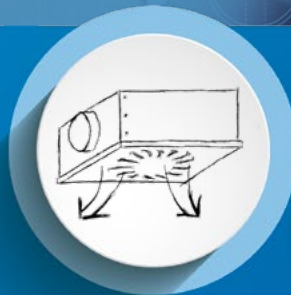

Supply and ex-
haust air systems



Maintenance and
service

Synergies with a system

Expertise for a sustainable future

Hürner Luft- und Umwelttechnik (air and environment engineering), **HLU** for short, combines unique fan and component knowledge with decades of experience in the field of supply and exhaust air systems and a great breadth of equipment know-how. We develop forward-looking system solutions that synergetically combine supply and exhaust air, exhaust air purification, sound and explosion protection, and energy efficiency.

Fan and component knowledge

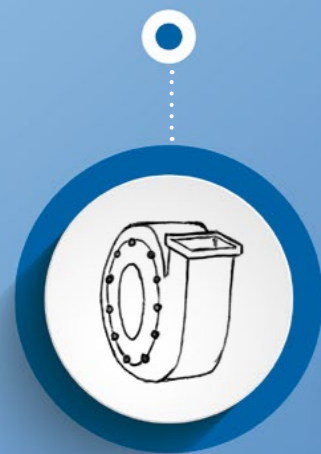

Equipment know-how

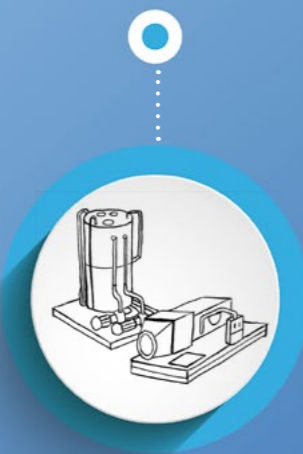

Expertise in ventilation technology



Project and service expertise



Specialists in corrosion-resistant plastics

Our ATEX-compliant plastic fans, components and equipment are used all over the world where maximum chemical resistance, reliability and durability are required.

Great project and service expertise

Our considerable project expertise means we can support our customers in all supply and exhaust air tasks. We plan, manufacture and install unique, custom-fit solutions for you and support you with maintenance and service.

Our values signpost the way forward

Progressive.

We have been actively shaping the market since 1928. We are driven to recognise future trends and needs early on and to deliver solutions to tomorrow's challenges today. To achieve this, we have an **average annual development budget of 340,000 euros** and invest around 600,000 euros each year in state-of-the-art technology and in expanding our production facilities.

Reliable.

Respecting commitments, deadlines and quality parameters 100 per cent is our top priority. Each of our **182 employees** feels personally responsible for this. This important aspect of our culture is clearly reflected in our **process and quality management**, which enables us to systematically maintain and optimise our reliability and dependability.

Measurable.

Our performance is measurable. From stock levels to delivery-date adherence and complaint rates, we place great importance on 100% transparency. The same is true at product level: with innovative sensors for predictive maintenance, we ensure continuous condition monitoring and complete transparency regarding the process reliability and performance of our systems and fans. Through this, we create **safety, transparency and trust**.

We are certified by:

- ISO 9001 certificate
- Water Resources Act (TÜV)
- Prequalification for public tenders
- SCC (occupational safety)
- Plastic welder certificates

Industry 4.0

Increasing challenges call for foresight and strong partners

Virtually every industry faces economic, social and environmental challenges. Industrial companies must invest massively in environmental technology in order to meet energy and climate policy goals. At the same time, rising energy costs are eating into margins. Against this backdrop, you need to be particularly far-sighted when making investment decisions.

The ability to recognise and exploit synergy potential becomes a crucial competitive advantage – and **HLU** is happy to support you in this.

We are here to help you!

With our products and services, we can support you in the areas of supply and exhaust air and of exhaust air purification. We can also assist you with maintenance and service for ventilation systems in the industrial, laboratory and commercial sectors. Our solutions meet the requirements for **chemical resistance** and **noise and explosion protection (ATEX)** and enable **significant energy savings through efficient heat recovery**.



With four divisions

HLU offers perfect solutions to all tasks.

Plastic fans and components

Fans and ventilation components made of corrosion-resistant plastics for use with chemically contaminated exhaust air and in potentially explosive areas (ATEX compliant).



Plastic equipment and system construction

Planning, construction, manufacturing and installation of plastic equipment and systems for custom requirements.



Supply and exhaust air systems

Energy-efficient supply and exhaust air systems to protect health and the environment in industrial, laboratory and research areas as well as refrigeration, air conditioning and ventilation technology in the commercial sector.

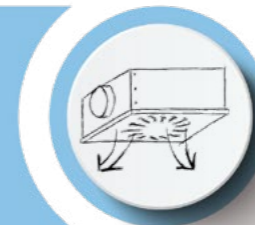

Maintenance and service

Minimisation of failure risk of ventilation plants and systems in the industrial, laboratory and commercial sectors through maintenance and service.



Present worldwide and on site when you need us

In order to guarantee you good accessibility, **HLU** is represented in numerous countries and can support you in all ventilation tasks. Competent and comprehensive.

Diez
Sube-HLU GmbH

Ransbach-Baumbach
Hürner Luft- und Umwelttechnik GmbH

Schwalbach am Taunus
Hürner Luft- und Umwelttechnik GmbH

Mücke-Atzenhain
Hürner Luft- und Umwelttechnik GmbH

- = Partners
- = Facilities
- = Subsidiaries

Malaysia
Huerner Funken Malaysia Sdn. Bhd.

Singapur
Huerner Funken Singapore Pte. Ltd.

China
Huerner Funken Environmental (SuZhou) Co., Ltd.

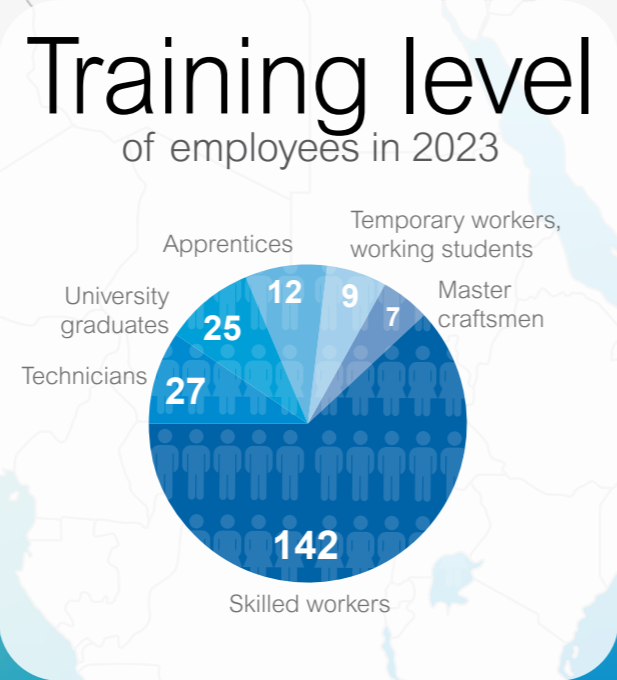
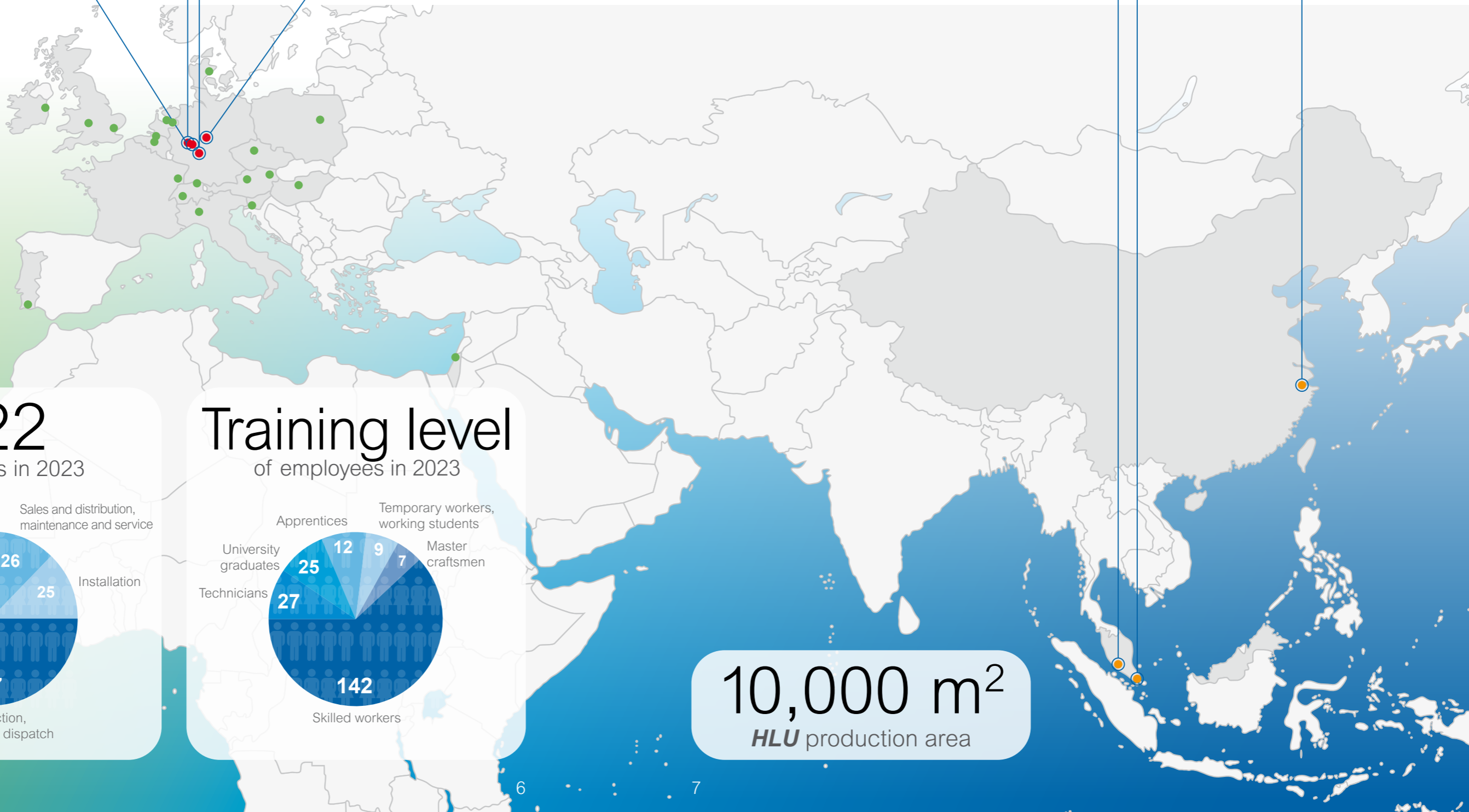

10,000 m²
HLU production area

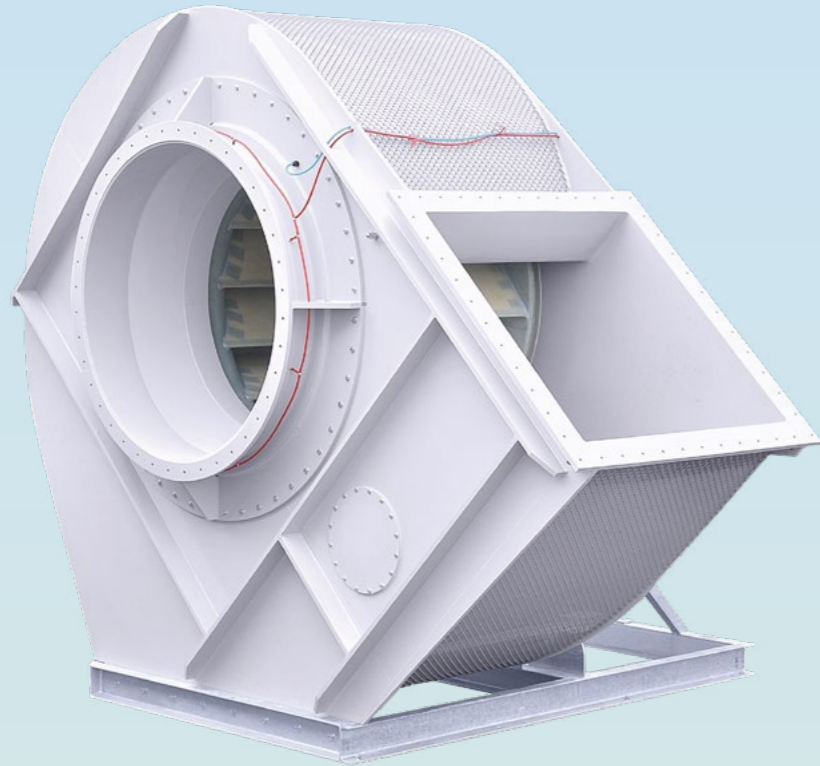

Experts since 1928

Plastic fans and components

HLU is a German manufacturer and specialist in fans and ventilation components made of **corrosion-resistant plastics** suitable for **chemically contaminated exhaust air** and in potentially explosive areas.

We translate our customers' requirements into **innovative solutions**. For example, 3D dimension sheets and QR codes on the fan nameplates are a matter of course for us, meaning the individual data card, spare parts list, declaration of conformity and operating instructions can be called up at any time.



20 m³/h



150.000 m³/h

Our high stock levels ensure the shortest possible delivery times, so we are a valuable and reliable partner especially in time-critical projects.

1000
motors

1400
impellers

800
casings

Delivery-date adherence

96 %

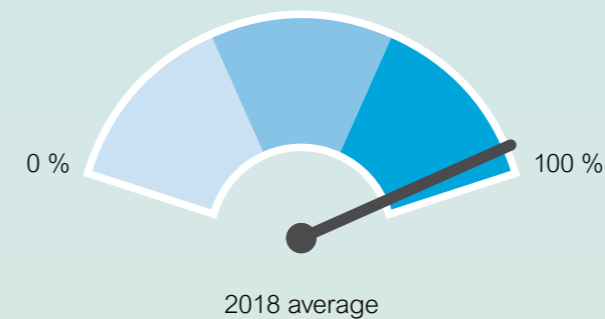

Complaints

1 %

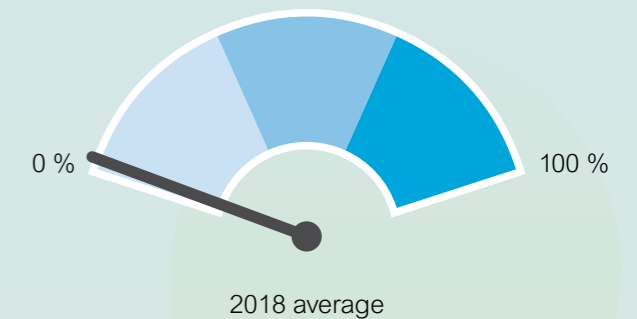

Some of the areas where **HLU** fans are used:

- Chemical industry
- Food industry
- Electroplating industry
- Laboratory buildings
- Universities
- Research institutes

Plastic fans and components

In addition to **fans**, our **exhaustive range of components** includes components for all kinds of requirements, such as predictive maintenance, and control and instrumentation (C&I) engineering, sound insulation and airtight shut-off.

Further accessories such as inspection covers, pipes, duct and shaped parts, and roof attachments complete our portfolio.

HLU manufactures in its own plants in Germany – quality made in Germany.

Quality control is carried out in accordance with DIN ISO 9001 and TÜV standards.

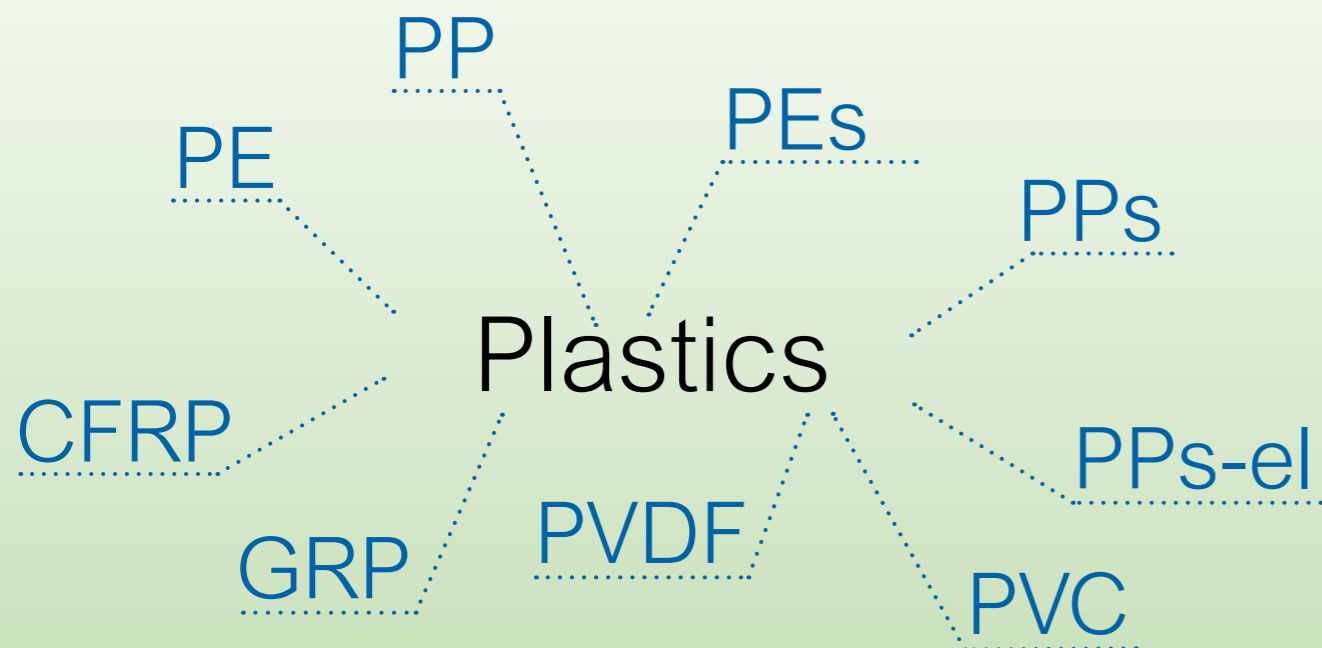
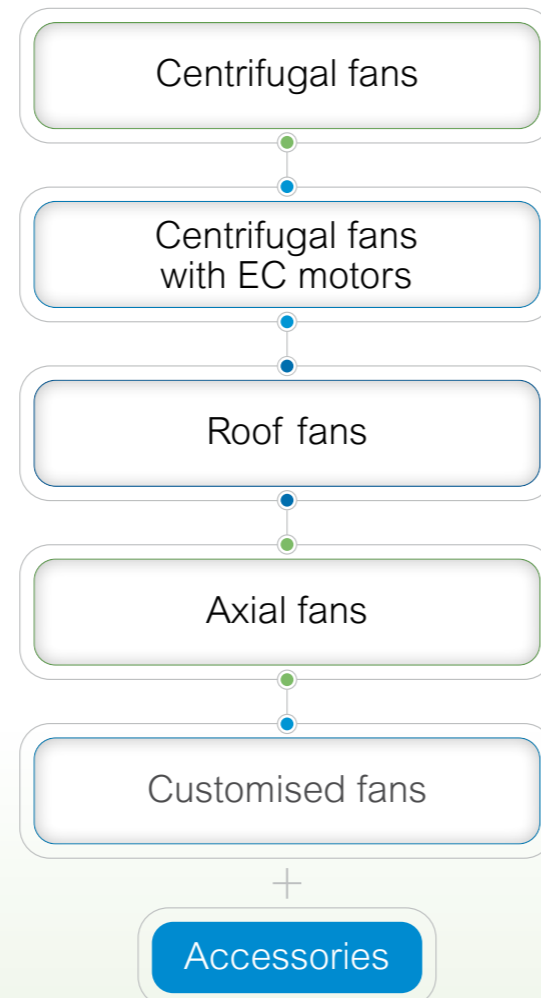

Tailor made and economical

Plastic equipment and system construction

HLU is an experienced and well recognised specialist company that can assist you with your individual requirements in accordance with the German Water Resources Act (WHG).

Following your specifications, we plan, construct and install **equipment and systems made of corrosion-resistant plastics that meet your requirements** and ensure compliance with country-specific legal regulations at all times.

Our product range includes exhaust air scrubbers, laboratory gas scrubbers, tanks, evaporators, spin separators and inertia droplet separators.

Our solutions are mainly used in wet chemical processes and have proven their worth in the following areas:

- Chemistry/pharmaceutical
- Semiconductor, solar and surface technology
- Waste and waste-water technology
- Composting
- Textile and food industry

Talk to us about your needs: we will find technically and economically compelling solutions to your special challenges.



Resource-saving solutions for safety and comfort

Supply and exhaust air systems

The requirements for occupational safety, environmental protection and health protection are constantly increasing and require measurably effective provisions in buildings and industrial plants. With energy- and resource-efficient supply and exhaust air systems, **HLU** helps you to meet your current challenges.

Comprehensive service for measurable satisfaction

Our services range from **planning** supply and exhaust air systems, **process development**, and component **project planning and production** to **installation and maintenance**.

We place a team with a high level of expertise and flexibility at your service, to ensure your installation is completed on time and within budget and to support you in achieving your goals.

Replacement of old fans with energy-saving modern fan and motor technology

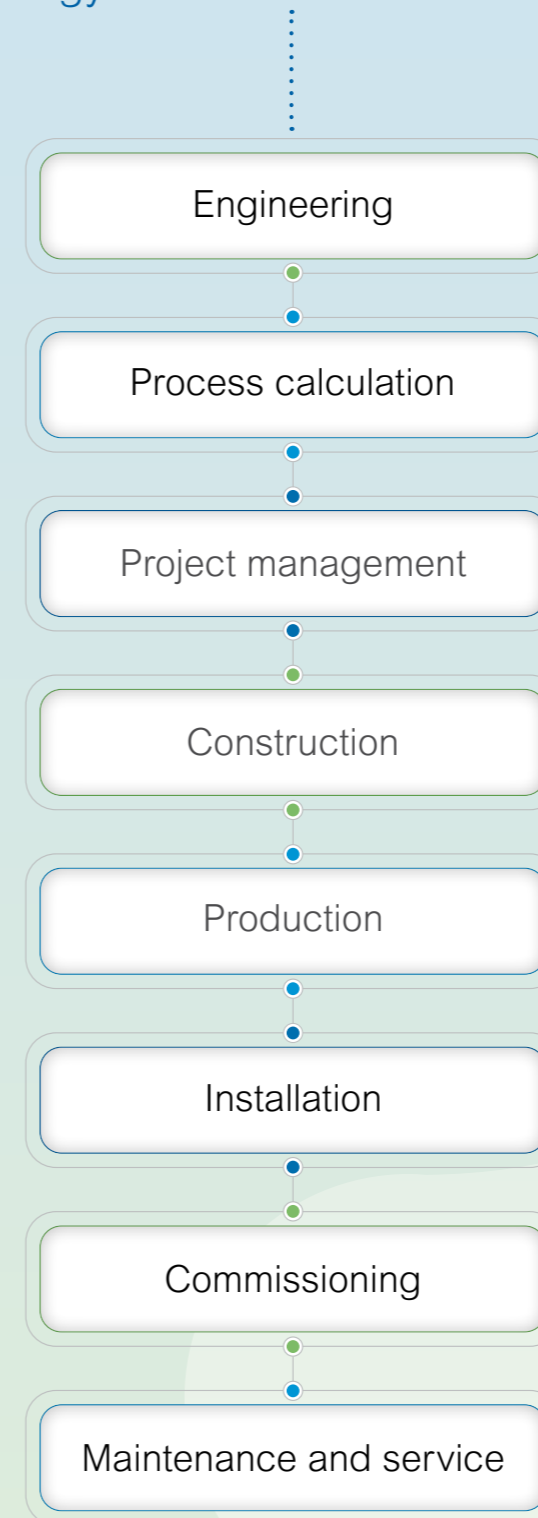

Monitoring with **HLU** sensors

State-of-the-art sensor technology means the condition and performance of your installations and fans can be continuously monitored, for maximum process reliability and efficiency.

The measured data on temperature, pressure, flow rate, current consumption and vibrations can be retrieved from any location via the **HLU** cloud solution.

Healthful air conditioning and ventilation technology

In the commercial sector, our supply and exhaust air systems ensure comfort and wellbeing. You will receive a system that is precisely matched to the building and the way it is used.

We design our systems for every possible type of requirement in the commercial and public sectors:

- Industrial and process ventilation
- Clean room air conditioning
- Laboratory ventilation
- Ventilation in animal sheds
- Hospital air conditioning
- Office air conditioning
- Ventilation for data centres
- Warehouse ventilation
- Underground car park ventilation
- Kitchen ventilation
- Smoke and heat exhaust systems
- Residential air conditioning systems

Supply and exhaust air systems



Energy-efficient plastic central exhaust air units

HLU's central air handling units have a proven record in the industrial sector for chemically contaminated industrial and process exhaust air.

Thanks to innovative heat-recovery concepts, plastic central air handling units enable **heat recovery** of 68% in accordance with DIN EN 308. They meet the requirements of the Ecodesign Directive of 2018 and are TÜV tested in accordance with DIN EN 1886.



Compliance with construction budgets – project management

100 %

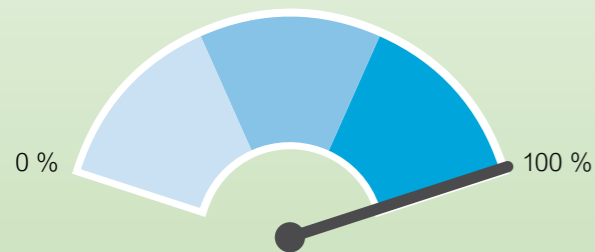

Compliance with construction deadlines – project management

98 %

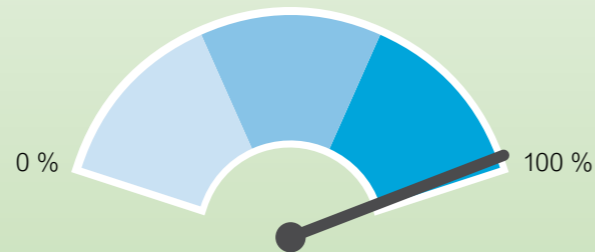

On site when you need us

Maintenance and service

For maximum process reliability with a minimum risk of failure, you need a powerful and reliable on-site partner.

With our comprehensive range of services, we are always there when fast and reliable solutions are needed.

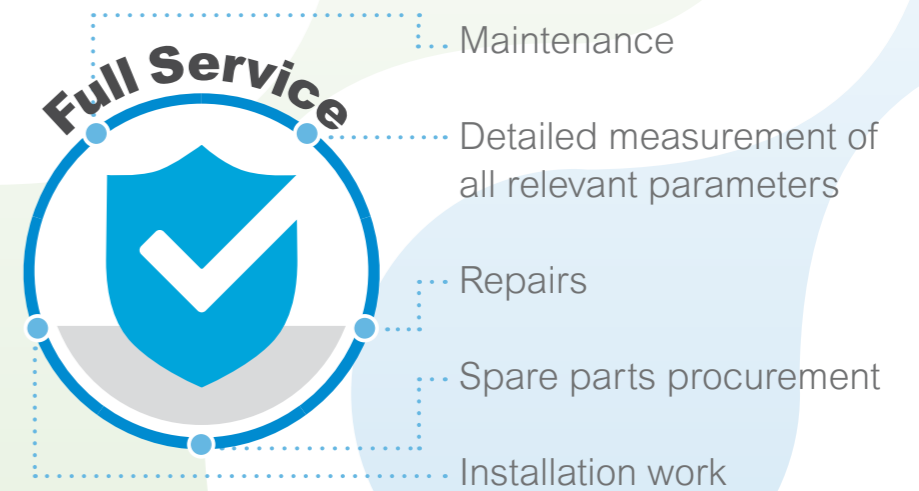

Maintenance and service

Maintenance is the best prevention

Almost any malfunction can be prevented by early fault detection, so good and regular maintenance is important. With over 90 years' experience and **state-of-the-art measurement technology**, we ensure **safety** and make certain that your ventilation systems operate efficiently and reliably. Should faults nevertheless occur, we are available around the clock to find the right solution for you.

Predictive maintenance – state-of-the-art measurement options for maximum safety

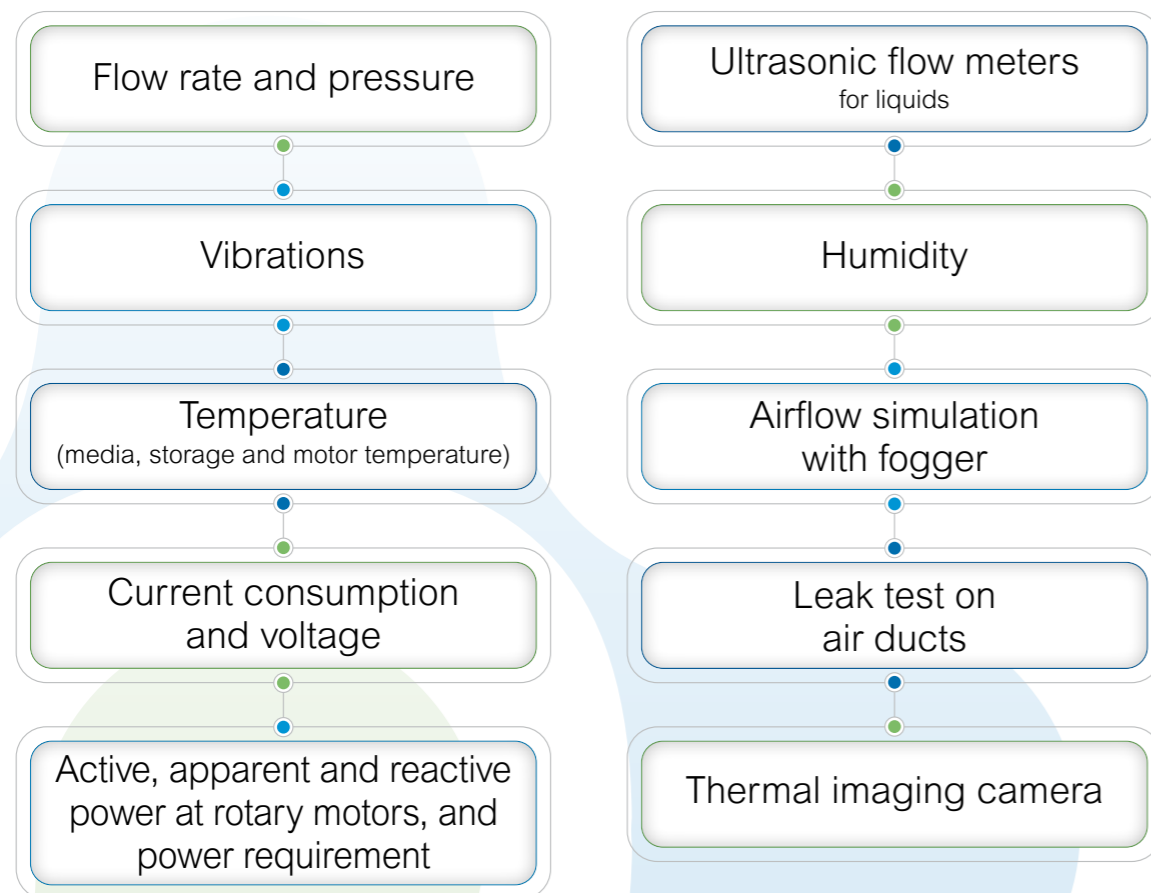

Reduction of downtime through regular maintenance

up to 90%

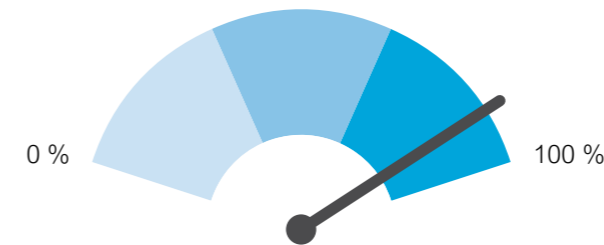

Satisfied maintenance customers

100%

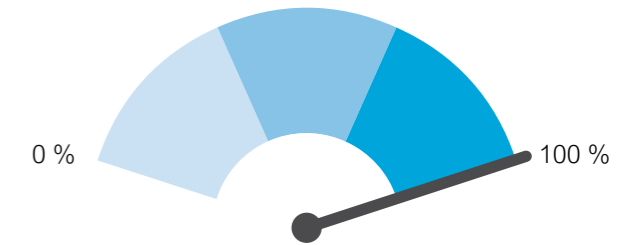

No contract termination due to dissatisfaction since 2010

Our 24h service is available right around the clock.



Team

We are proud of our professional and highly committed team of qualified and experienced employees. Thanks to them, we can assure our high performance in planning, manufacturing and installing complete ventilation systems – from supply air to exhaust air.

We organise our employees' training and development in our in-house **HLU** Coaching Academy. Our engineers, plastic welders, technicians and consultants deepen and update their knowledge regularly in professional development courses. In this way, we safeguard our innovative strength and continue to develop the progressive services with which we provide you with reliable support.

We have firmly anchored our values in our corporate and management culture. Our thoughts and actions are based on these values:

Progressive. Reliable. Measurable.

We set responsibilities, deadlines and prices bindingly and unambiguously before a project starts. This allows us to create transparency for you, reduce the number of contact people and unnecessary costs, and optimise the project length.



Dr. Ralph-Dieter Schrey
Managing Director
and owner



Lars Roßkothen
Managing Director
of Sales and
Marketing



Peter Fisches
Managing Director
of Technology and
Plant Engineering

Fans and components



Hartmut Groh
Head of Sales
Tel. +49 6401 9180 - 137
Mobile +49 171 620 0476
Email h.groh@hlu.eu



Adrian Costiniuc
Sales GER-East and export
Tel. +49 6401 9180 - 162
Mobile +49 151 4001 1017
Email a.costiniuc@hlu.eu



Sarah Di Cicco
Sales GER-North, West and Export
Tel. +49 6401 9180 - 132
Mobile +49 171 934 3439
Email s.dicicco@hlu.eu



Christoph Reimers
Sales GER-South, Austria, Switzerland
Tel. +49 6401 9180 - 174
Mobile +49 160 725 4822
Email c.reimers@hlu.eu

Plastic equip. and system construction



Frank Kluge
**Authorized Officer I
Head of Technical Sales**
Tel. +49 2623 92959 - 13
Mobile +49 172 656 2072
Email f.kluge@hlu.eu



Nikolaus Wessler
Sales | Project management
Tel. +49 2623 92959 - 34
Mobile +49 171 310 6349
Email n.wessler@hlu.eu

Central +49 6401 9180 – 0
Email info@hlu.eu

Webshop

You can place your orders quickly and easily through our webshop: www.hlu-shop.eu

Supply and exhaust air systems



Christian Litzinger
**Head of Sales, Project Management,
Maintenance & Service**
Tel. +49 6401 9180 - 242
Mobile +49 160 516 8892
Email c.litzinger@hlu.eu



Manuel Langstroff
Technical Sales
Tel. +49 6401 9180 - 124
Mobile +49 175 401 9731
Email m.langstroff@hlu.eu



Julian Werner
Technical Sales
Tel. +49 6401 9180 - 236
Mobile +49 151 1620 7087
Email j.werner@hlu.eu

Maintenance & Service

Maintenance & Service on AHU and refrigeration + C&I:



Torsten Baumgarten
**Authorized Officer I Head of Sales and
Technology**
Tel. +49 6978 9900 - 26
Email service@hlu.eu

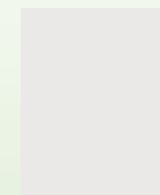

Ivan Pintaric
Head of Maintenance & Service
Tel. +49 6978 9900 - 20
Email service@hlu.eu

Repairs, maintenance and spare parts for plastic fans and components



Thomas Schmitt
Tel. +49 6401 9180 - 116
Mobile +49 175 404 8021
Email t.schmitt@hlu.eu



Hürner Luft- und Umwelttechnik

Hürner Luft- und Umwelttechnik GmbH

Ernst-Hürner-Straße
35325 Mücke-Atzenhain
Germany

Tel. +49 6401 9180 - 0
Fax +49 6401 9180 - 142

info@hlu.eu
www.hlu.eu