

Welded centrifugal fans made of plastic

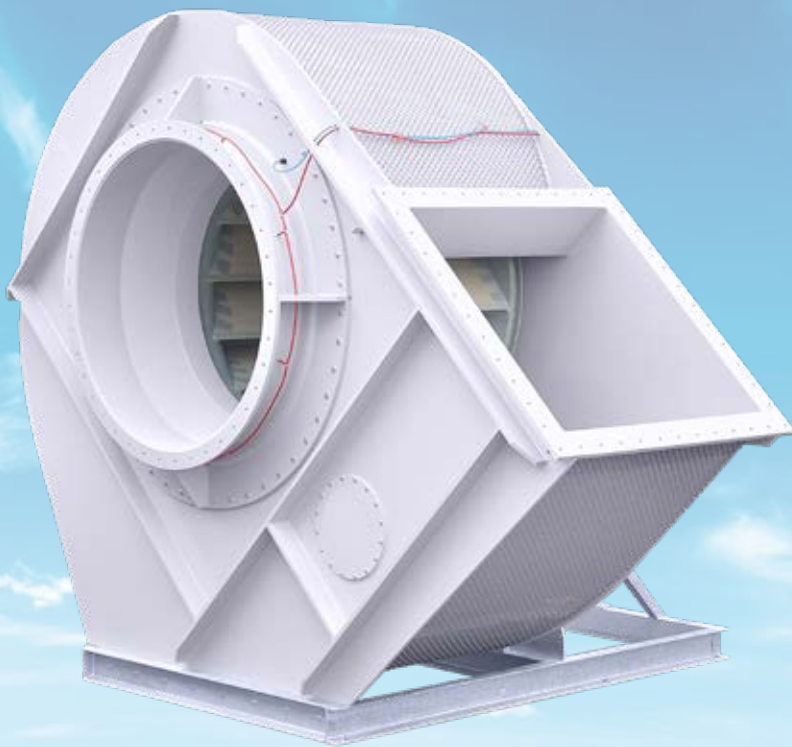

powerful energy-efficient
application-optimised



Index

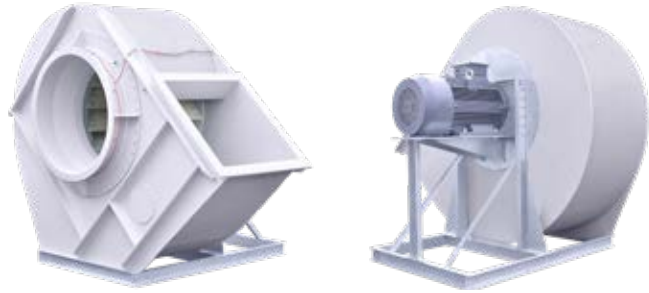

Welded centrifugal fans made of plastic

Advantages, Design, Application	3
HF R ...-13 D series Direct drive	
Specification	4
Dimension sheet	5
HF R ...-13 RF series Belt drive; flange double bearing	
Specification	6
Dimension sheet	7
HF R ...-13 RB series Belt drive; block bearing	
Specification	8
Dimension sheet	9
Characteristic curve and sound data	10
Accessories	32
Wide spectrum of materials	39
Thermoplastic	40
Fibre-reinforced plastic	42
Steel impellers with coating	44
From design to the customer	45
ATEX explosion protection	48
Housing positions	51



HF centrifugal fans
HF R ...-13 D / R series

Advantages

- Corrosion resistant
- High efficiency level
- No metal parts in the air flow
- Wide range of materials for all applications

Design

- Housing made of welded or laminated plates
- Wide range of impeller variants
- Frames galvanised as standard
- Use of all industrial motors in B3 possible
- Several drive variants (direct, belt, clutch)

Application

- Transportation of air and corrosive gases
- Handling of explosive atmospheres from Ex zones 2 and 1
- Central exhaust air from laboratory buildings
- Chemicals and pharmaceutical industries
- Galvanic plants
- Semiconductor industry

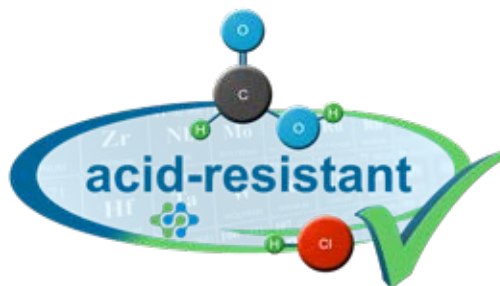

Specification

HF - Centrifugal fan direct driven

in efficiency optimized premium version „blue Hfan“

Corrosion resistant plastic radial fan with housing in thermoplastics, in welded version, one inlet side, condensate drainage at the lowest point of the housing, splinter protection according to accident prevention rules as plastic coated wire mesh, inspection opening on the inlet side. Impeller with backward curved blades, statically and dynamically balanced, quality of balancing at least G 6.3 (DIN ISO 21940-11), floating-mounted on the motor shaft. Fan frame in strong, welded steel construction, galvanised version, with motor support plate, suitable for fan housing with impeller and motor.

Manufacturer	: Hürner Luft- und Umwelttechnik	
Type	: HF R ... - .. D	
Housing-material	: ...	
Impeller-material	: ...	
Housing position	: ...	
Inlet diameter	: ...	mm
Medium	: exhaust air	
Volume flow	: ...	m ³ /h
Total pressure difference	: ...	Pa
Static pressure difference	: ...	Pa
Schalldruckpegel Lp2A (1 m)	: ...	dB(A)
SFP	: ...	W/(m ³ /s)
Motor power	: ...	kW
Voltage	: ...	V
Frequency	: ...	Hz
Rated current	: ...	A
Enclosure / motor protection	: IP 55 / PTC	

Accessories:



Protection grid
P. 32



Shaft seal
P. 34



Flange connection
P. 34



Motor cover
P. 35

HF R ...-13 D

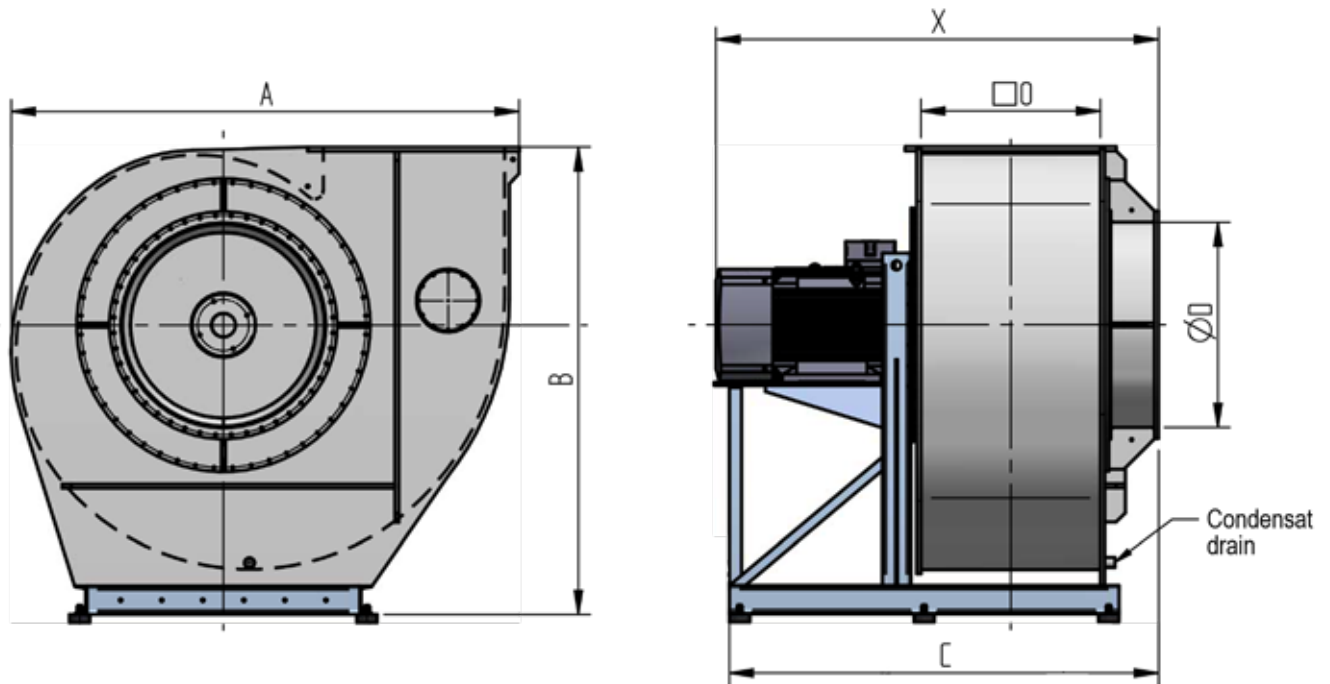

Size - Type ØD	Dimensions [mm]					kg*
	A	B	C	□0	X*	
450-13 D	1147	1140	1030	390	1200	360
500-13 D	1268	1275	1085	434	1200	380
560-13 D	1415	1436	1213	482	1500	590
630-13 D	1582	1556	1283	548	1700	730
710-13 D	1782	1746	1475	604	1800	810
800-13 D	1995	1840	1596	692	1900	1040
900-13 D	2242	2042	1977	779	2300	1520
1000-13 D	2478	2278	2093	875	2400	1800
1120-13 D	2791	2548	2230	980	2800	3300
1250-13 D	3105	2850	2900	1116	2900	3480
1400-13 D	3450	3150	3000	1360	3200	4000
1600-13 D	4000	3900	2900	1420	3000	4500

* depending on motor size and motor type
indicated dimensions: DS3 with max. motor



Sound enclosure
P. 36



Repair switch
P. 37



Fans optionally available
for Ex-Zone!
P. 48

Specification

HF - centrifugal fan belt driven

in effizienzoptimierter Premiumausführung „blue Hfan“

Corrosion resistant plastic radial fan with housing in thermoplastics, in welded version, one inlet side, condensate drainage at the lowest point of the housing, splinter protection according to accident prevention rules as plastic coated wire mesh, inspection opening on the inlet side. Shaft passage with Kera/Viton-seal as standard. Impeller with backward curved blades, statically and dynamically balanced, quality of balancing at least G 6.3 (DIN ISO 21940-11), floating-mounted via flange double bearing (RF). Fan frame in strong, welded steel construction, galvanised version, with motor support plate and with belt guard, suitable for fan housing with impeller, for the belt drive and motor.

Manufacturer	: Hürner Luft- und Umwelttechnik		
Type	: HF R ... - .. RF		
Housing-material	: ...		
Impeller-material	: ...		
Housing position	: ...		
Inlet diameter	: ...	mm	
Medium	: exhaust air		
Volume flow	: ...	m ³ /h	
Total pressure difference	: ...	Pa	
Static pressure difference	: ...	Pa	
Schalldruckpegel Lp2A (1 m)	: ...	dB(A)	
SFP	: ...	W/(m ³ /s)	
Motor power	: ...	kW	
Voltage	: ...	V	
Frequency	: ...	Hz	
Rated current	: ...	A	
Enclosure / motor protection	: IP 55 / PTC		

Accessories:



Protection grid
P. 32



Shaft seal
P. 34



Flange connection
P. 34



Motor cover
P. 35

HF R ...-13 RF

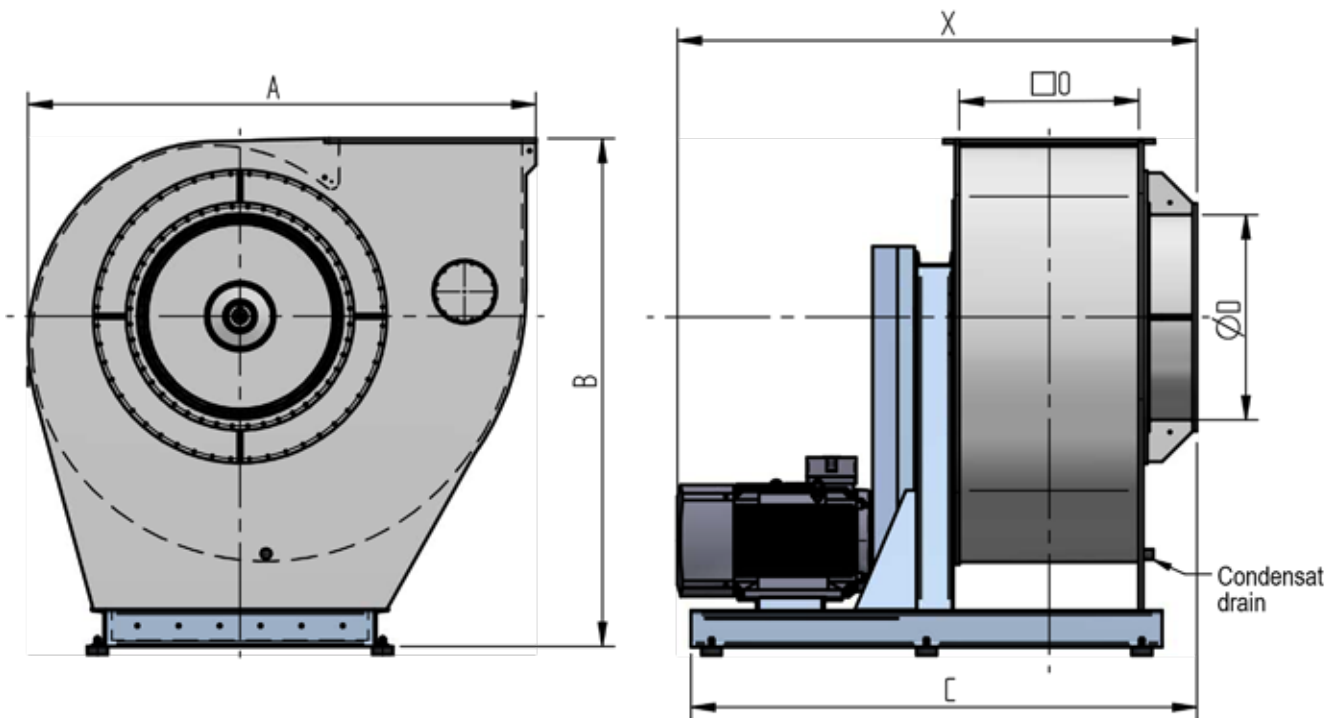

Size - Type	Dimensions [mm]						kg*
	ØD	A	B	C*	L	□0	
450-13 RF	1147	1160	1415	650	394	1400	400
500-13 RF	1268	1275	1565	720	434	1500	500
560-13 RF	1415	1436	1653	800	482	1600	700
630-13 RF	1580	1591	1838	900	550	1800	800
710-13 RF	1782	1806	1967	1000	604	2000	1000
800-13 RF	1995	2015	2240	1190	692	2100	1130
900-13 RF	2242	2262	2438	1240	779	2500	1790
1000-13 RF	2477	2478	2519	1390	869	2800	1940
1120-13 RF							
1250-13 RF							
1400-13 RF							
1600-13 RF							

* depending on motor size and motor type
indicated dimensions: DS3 with max. motor



Sound enclosure
P. 36



Repair switch
P. 37



Fans optionally available
for Ex-Zone!
P. 48

Specification

HF - centrifugal fan belt driven

in efficiency optimized premium version „blue Hfan“

Corrosion resistant plastic radial fan with housing in thermoplastics, in welded version, one inlet side, condensate drainage at the lowest point of the housing, splinter protection according to accident prevention rules as plastic coated wire mesh, inspection opening on the inlet side. Shaft passage with Kera/Viton-seal as standard. Impeller with backward curved blades, statically and dynamically balanced, quality of balancing at least G 6.3 (DIN ISO 21940-11), floating-mounted via pad thrust bearings (RB). Fan frame in strong, welded steel construction, galvanised version, with motor support plate and with belt guard, suitable for fan housing with impeller, for the belt drive and motor.

Manufacturer	: Hürner Luft- und Umwelttechnik	
Type	: HF R ... - .. RB	
Housing-material	: ...	
Impeller-material	: ...	
Housing position	: ...	
Inlet diameter	: ...	mm
Medium	: exhaust air	
Volume flow	: ...	m ³ /h
Total pressure difference	: ...	Pa
Static pressure difference	: ...	Pa
Schalldruckpegel Lp2A (1 m)	: ...	dB(A)
SFP	: ...	W/(m ³ /s)
Motor power	: ...	kW
Voltage	: ...	V
Frequency	: ...	Hz
Rated current	: ...	A
Enclosure / motor protection	: IP 55 / PTC	

Accessories:



Protection grid
P. 32



Shaft seal
P. 34



Flange connection
P. 34



Motor cover
P. 35

HF R ...-13 RB

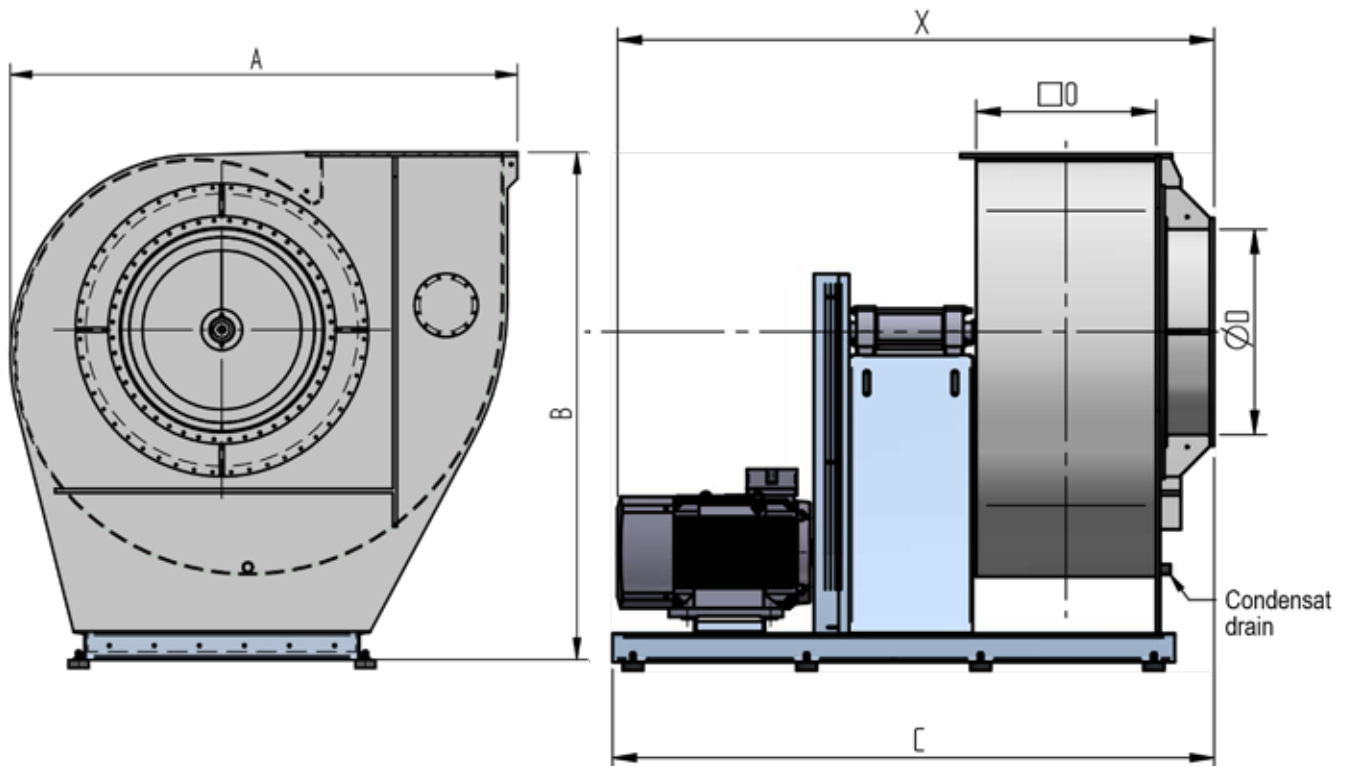

Size - Type	Dimensions [mm]						kg*
	ØD	A	B	C	L	□0	
450-13 RB	1146	1160	1670	650	390	1700	470
500-13 RB	1268	1275	1734	710	434	1800	510
560-13 RB	1415	1436	1966	800	482	2200	860
630-13 RB	1586	1586	1950	910	550	2200	800
710-13 RB	1774	1806	2328	1000	610	2400	1100
800-13 RB	1995	2015	2509	1100	692	2500	1200
900-13 RB	2234	2272	2733	1250	779	2800	2000
1000-13 RB	2478	2478	2933	1400	869	3000	2200
1120-13 RB	2786	2580	3061	1540	981	3000	2260
1250-13 RB							
1400-13 RB							
1600-13 RB							

* depending on motor size and motor type
indicated dimensions: DS3 with max. motor



Sound enclosure
P. 36



Repair switch
P. 37



Fans optionally available
for Ex-Zone!
P. 48

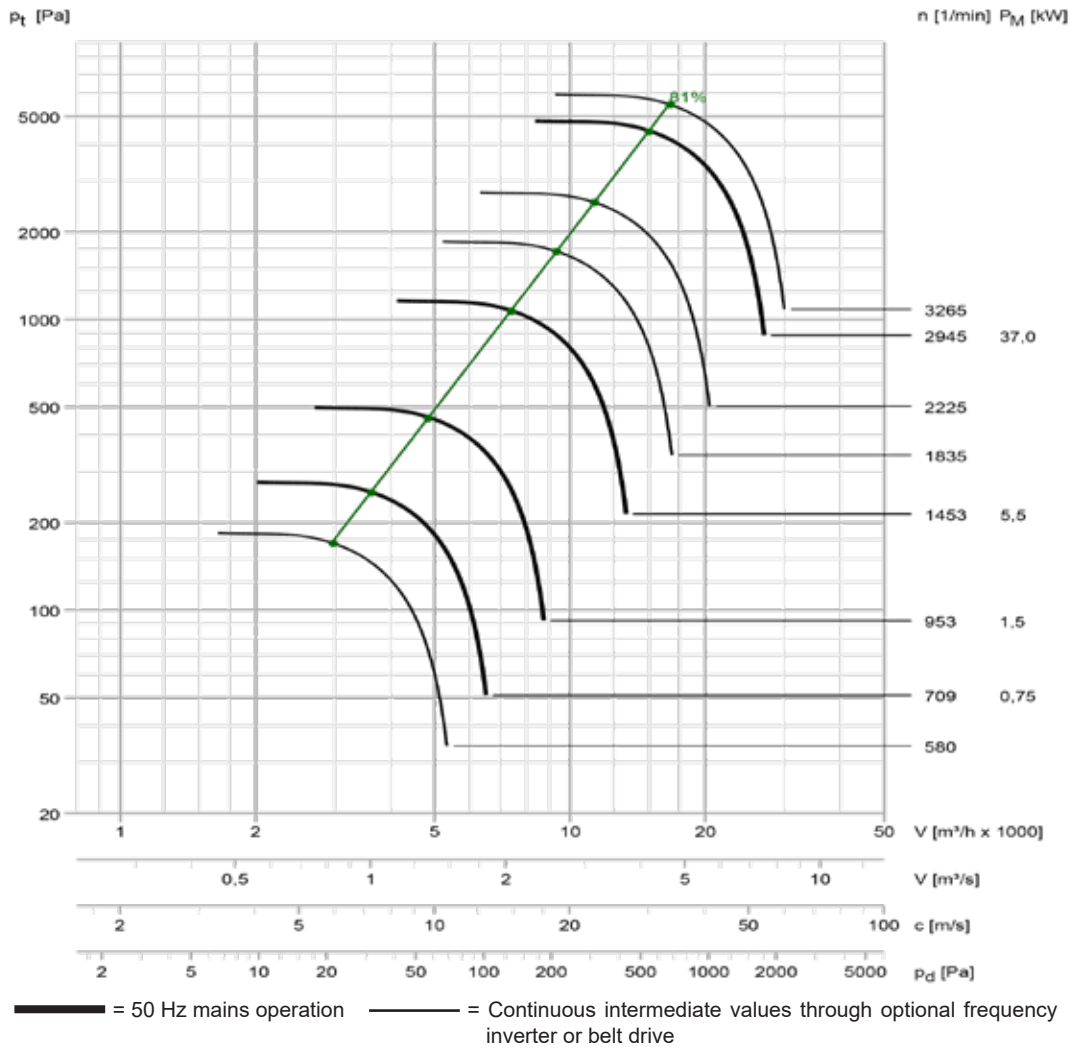

Acoustic level according to DIN 45635									
Speed [1/min]	inlet level / outlet level of the duct sound level non-valuated; Lw3 = Lw4 [dB]								Lp2A (1 m) [dB(A)]
	63	125	250	500	1000	2000	4000	8000	
3265	113	113	111	109	111	102	97	92	93
2945	110	109	108	111	103	99	94	88	90
2225	103	102	101	103	94	90	85	78	82
1835	99	97	95	98	89	84	79	72	76
1453	92	91	94	85	81	76	70	64	68
953	82	80	82	73	69	63	57	49	57
709	74	76	68	64	59	53	46	38	46
580	69	71	63	58	53	47	40	32	41

Accessories:



Protection grid
P. 32



Shaft seal
P. 34



Flange connection
P. 34



Motor cover
P. 35

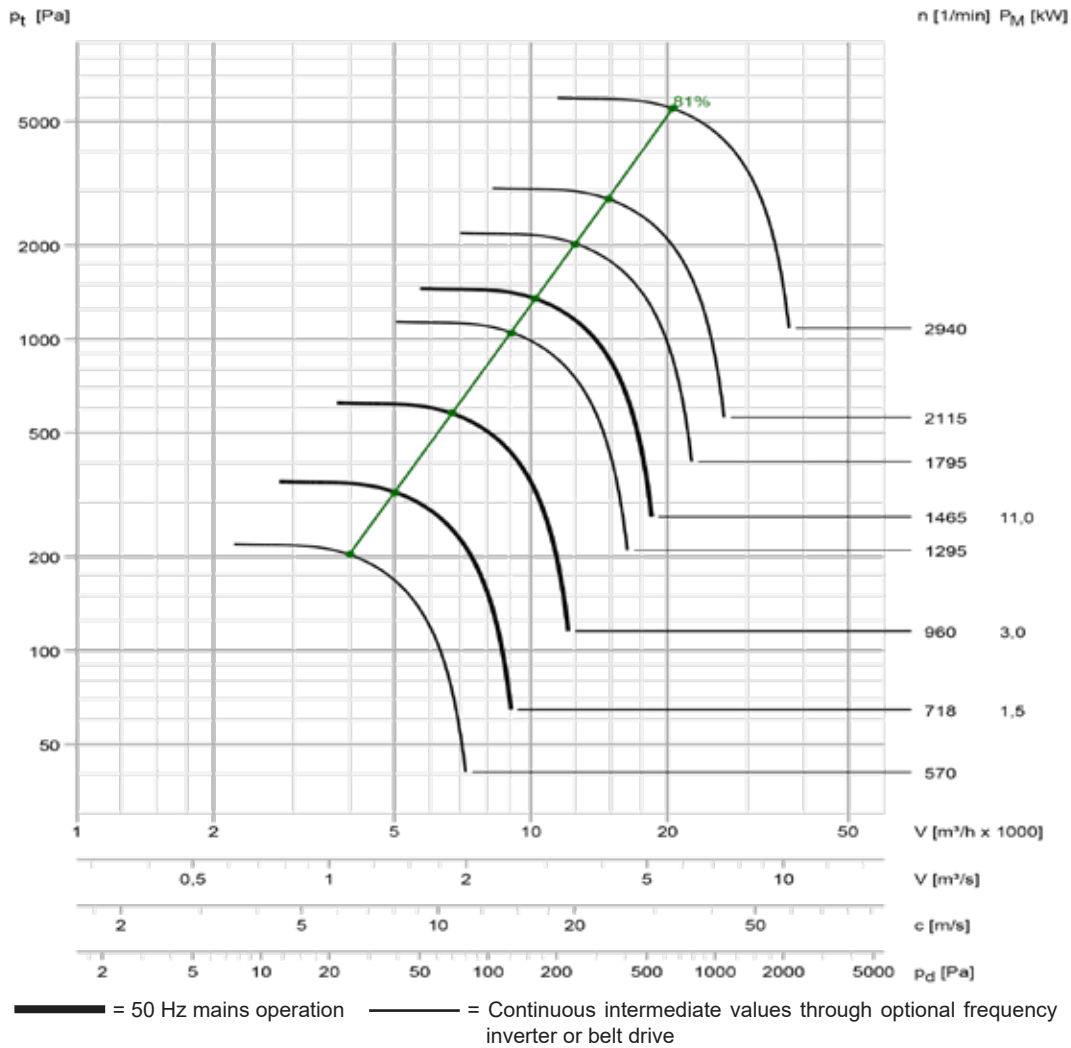

Acoustic level according to DIN 45635									
Speed [1/min]	inlet level / outlet level of the duct sound level non-valuated; Lw3 = Lw4 [dB]								Lp2A (1 m) [dB(A)]
	63	125	250	500	1000	2000	4000	8000	
2940	114	113	112	114	106	102	97	91	93
2115	106	105	103	105	97	92	87	80	83
1795	102	101	99	101	92	87	82	75	79
1465	96	95	97	89	85	80	74	68	72
1295	93	92	94	86	82	76	70	63	68
960	68	84	86	77	73	67	61	53	60
718	78	80	72	68	63	57	50	43	50
570	72	74	66	61	56	50	43	35	44



Sound enclosure
P. 36



Repair switch
P. 37



Fans optionally available
for Ex-Zone!
P. 48

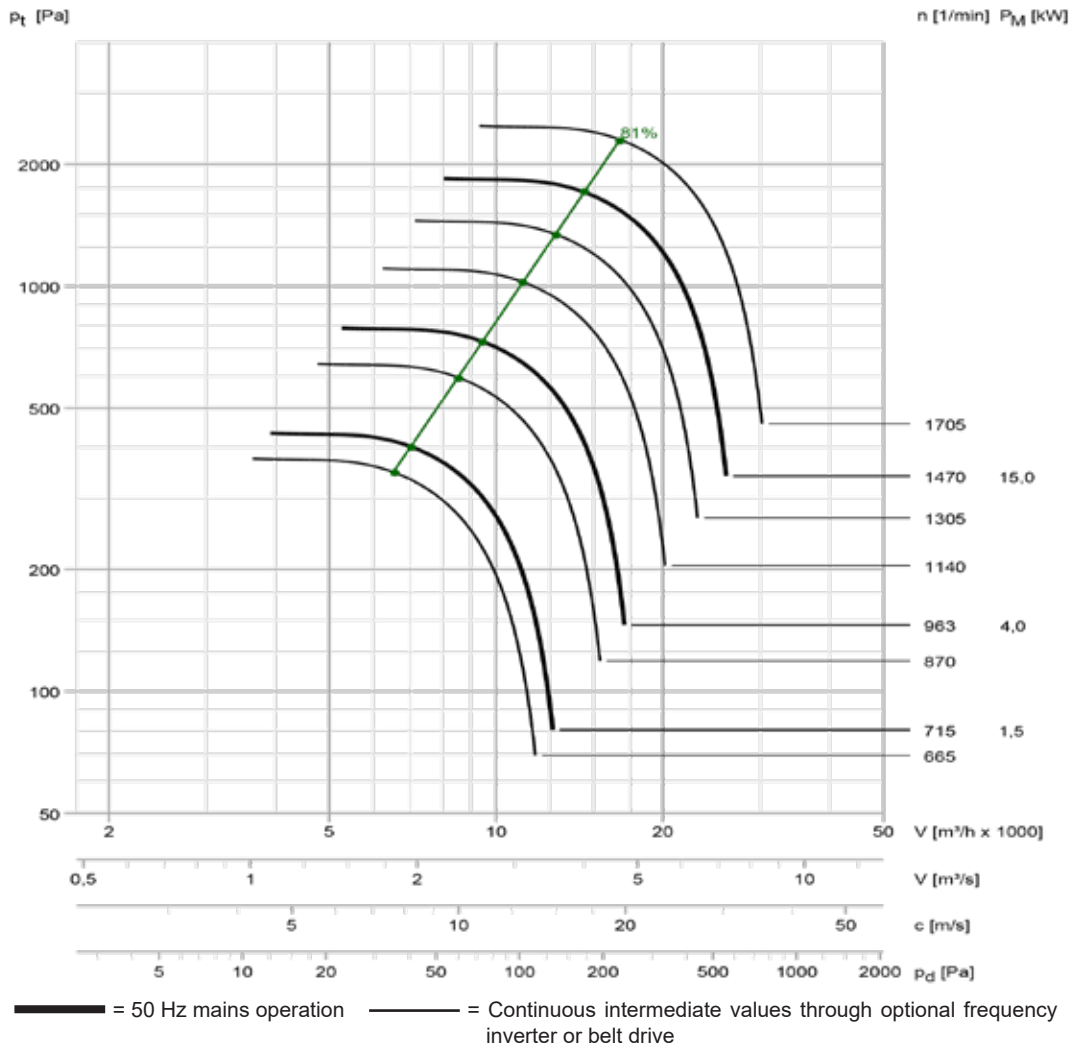

Acoustic level according to DIN 45635									
Speed [1/min]	inlet level / outlet level of the duct sound level non-valuated; Lw3 = Lw4 [dB]								Lp2A (1 m) [dB(A)]
	63	125	250	500	1000	2000	4000	8000	
1705	104	103	101	103	94	90	84	77	82
1470	100	99	101	93	89	84	78	72	77
1305	97	96	98	90	86	81	75	68	73
1140	94	92	95	86	82	76	70	63	70
963	90	88	90	81	77	71	65	57	65
870	87	85	87	78	74	68	61	54	62
715	81	84	76	72	67	61	54	46	55
665	80	82	74	70	65	59	52	44	53

Accessories:

 Protection grid
P. 32

 Shaft seal
P. 34

 Flange connection
P. 34

 Motor cover
P. 35

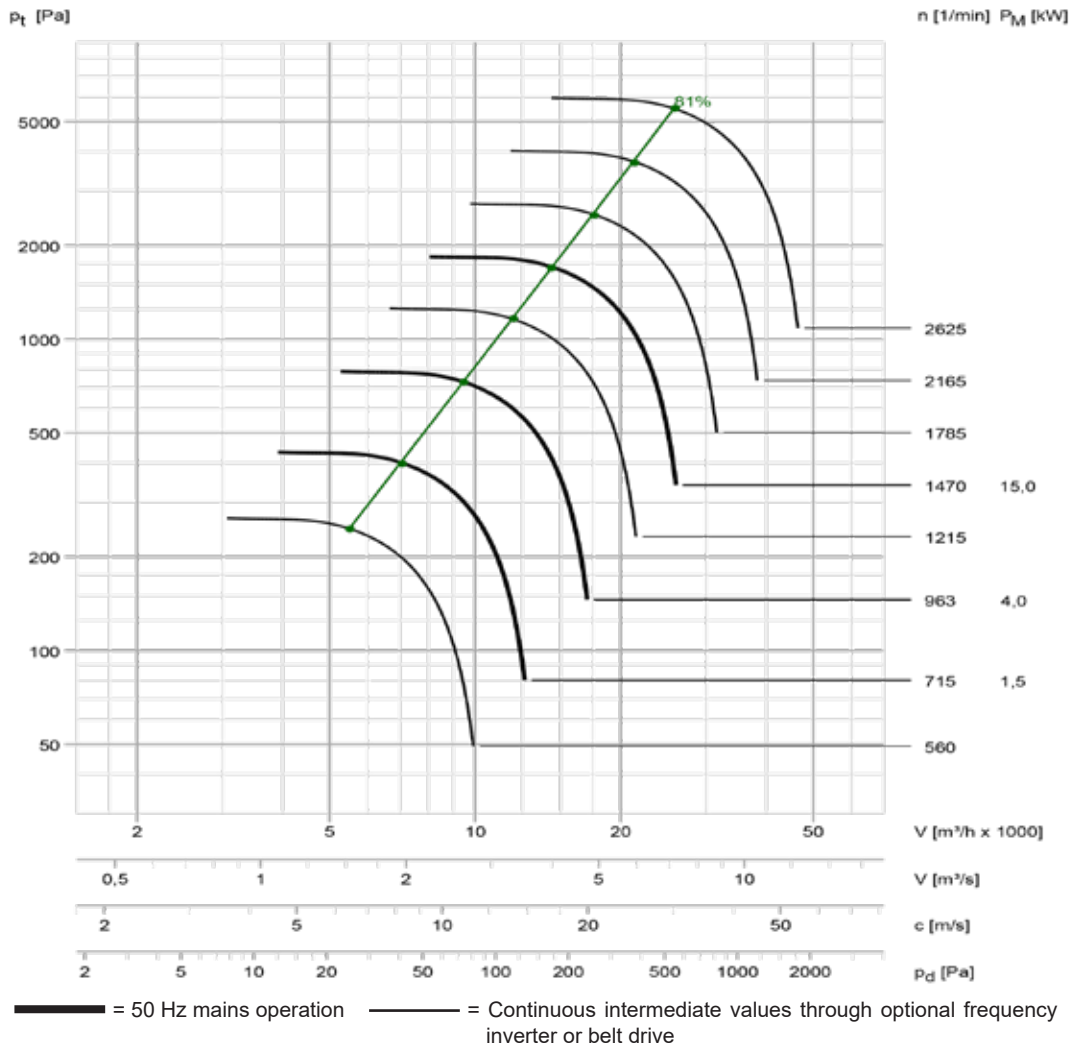

Acoustic level according to DIN 45635									
Speed [1/min]	inlet level / outlet level of the duct sound level non-valuated; Lw3 = Lw4 [dB]								Lp2A (1 m) [dB(A)]
	63	125	250	500	1000	2000	4000	8000	
2625	115	114	113	115	107	103	98	92	93
2165	110	109	108	110	101	97	91	85	88
1785	105	104	102	104	96	91	85	79	82
1470	100	99	101	93	89	84	78	72	75
1215	95	94	96	88	84	78	72	65	70
963	90	88	90	81	77	71	65	57	46
715	81	84	76	72	67	61	54	46	53
560	75	78	69	65	59	53	46	38	46



Sound enclosure
P. 36



Repair switch
P. 37



Fans optionally available
for Ex-Zone!
P. 48

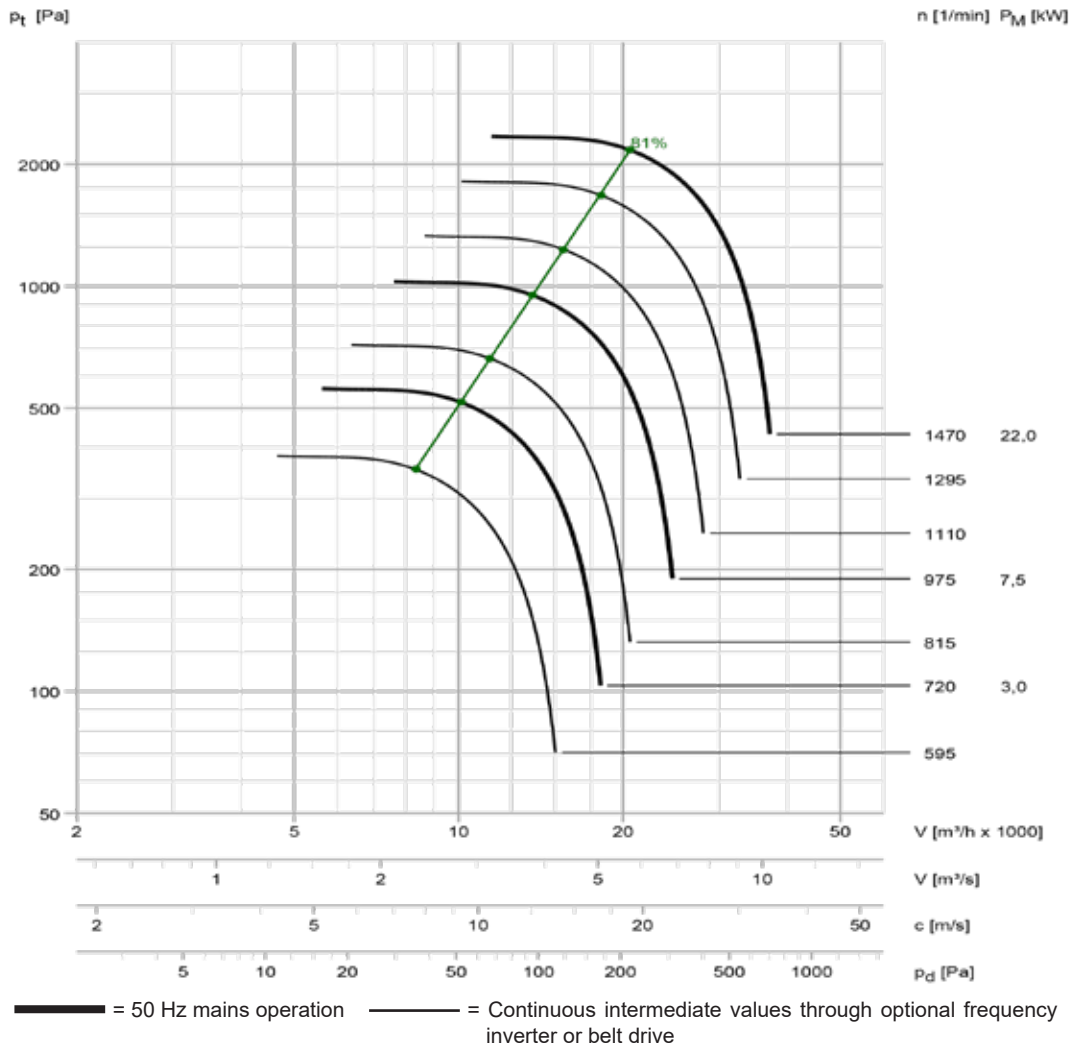

Acoustic level according to DIN 45635									
Speed [1/min]	inlet level / outlet level of the duct sound level non-valuated; Lw3 = Lw4 [dB]								Lp2A (1 m) [dB(A)]
	63	125	250	500	1000	2000	4000	8000	
1470	104	103	106	97	93	88	83	76	80
1295	101	100	102	94	90	84	78	71	77
1110	97	96	98	89	85	80	73	66	72
975	94	92	95	86	81	76	69	62	69
815	90	88	90	81	76	70	63	56	64
720	86	88	80	76	71	65	58	51	58
595	81	83	75	71	65	59	52	44	53

Accessories:

 Protection grid
P. 32

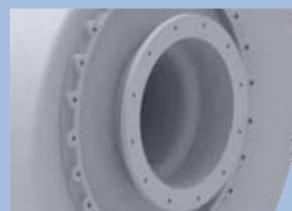
 Shaft seal
P. 34

 Flange connection
P. 34

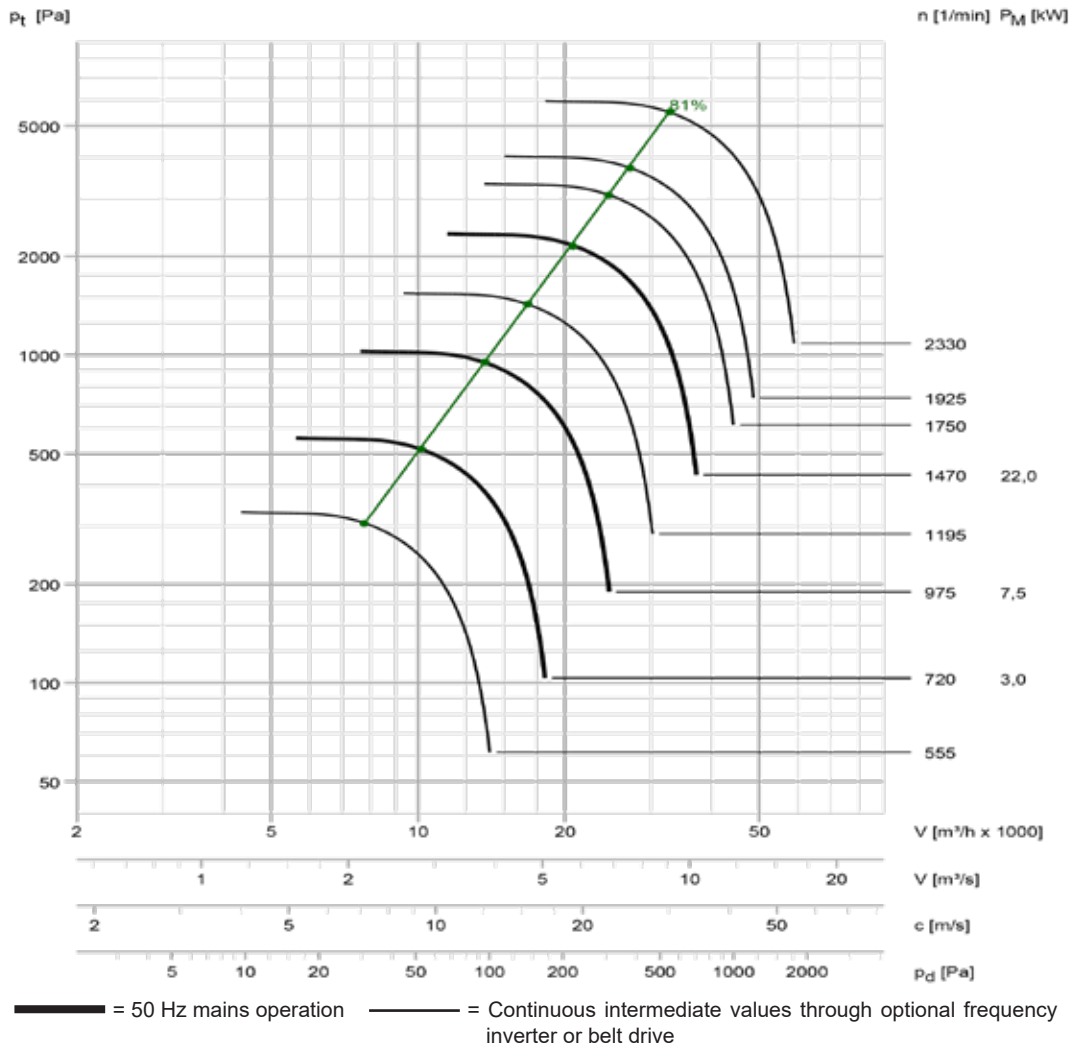
 Motor cover
P. 35



Acoustic level according to DIN 45635									
Speed [1/min]	inlet level / outlet level of the duct sound level non-valuated; Lw3 = Lw4 [dB]								Lp2A (1 m) [dB(A)]
	63	125	250	500	1000	2000	4000	8000	
2330	116	115	114	116	108	103	98	92	93
1925	111	110	109	111	102	97	92	85	87
1750	109	108	106	108	99	94	89	82	85
1470	104	103	106	97	93	88	83	76	78
1195	99	98	100	92	87	82	76	69	73
975	94	92	95	86	81	76	69	62	67
720	86	88	80	76	71	65	58	51	56
555	79	82	73	69	63	57	50	42	49



Sound enclosure
P. 36



Repair switch
P. 37



Fans optionally available
for Ex-Zone!
P. 48

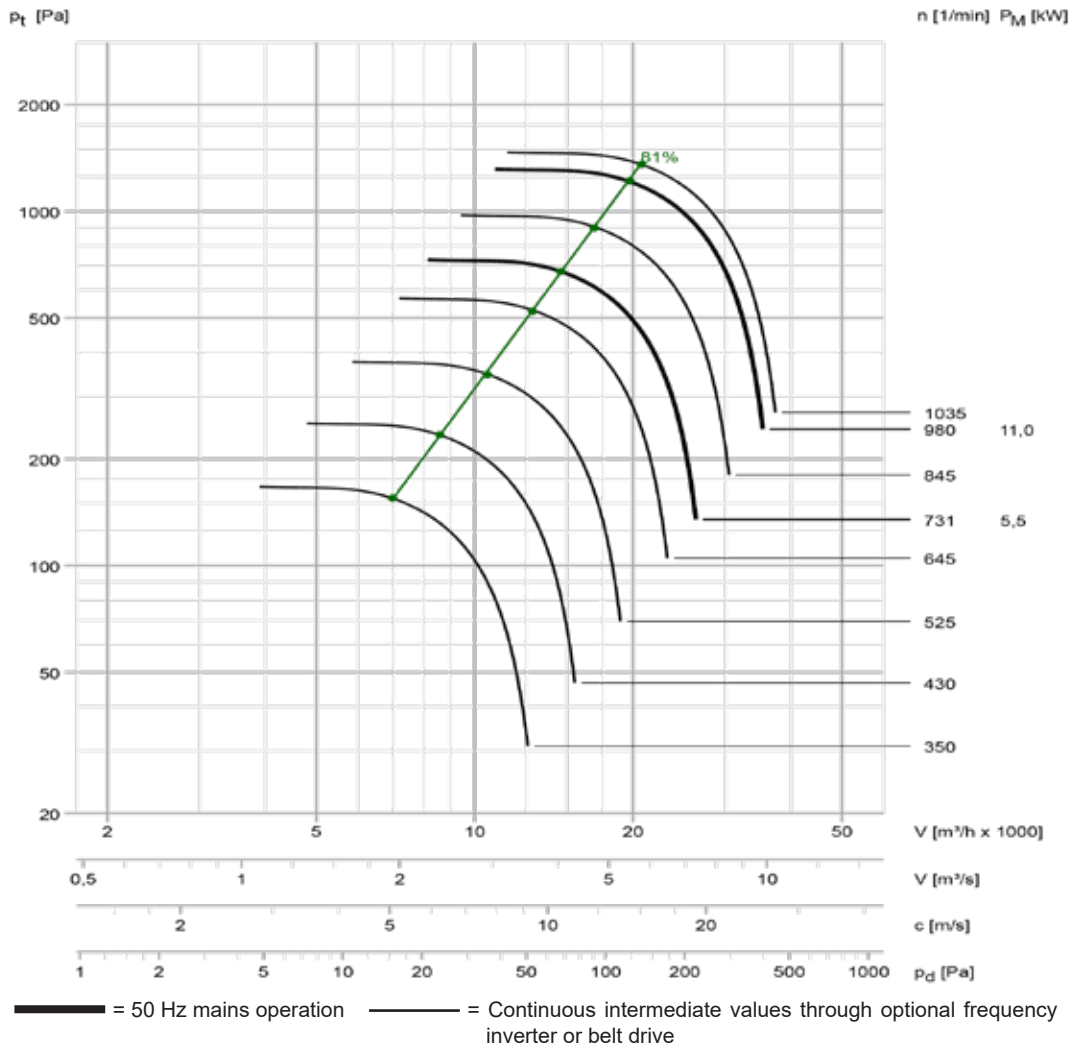

Acoustic level according to DIN 45635									
Speed [1/min]	inlet level / outlet level of the duct sound level non-valuated; Lw3 = Lw4 [dB]								Lp2A (1 m) [dB(A)]
	63	125	250	500	1000	2000	4000	8000	
1035	100	98	100	92	87	82	75	68	74
980	98	97	99	90	85	80	74	66	72
845	95	93	95	86	81	75	69	61	68
731	90	93	85	81	76	70	63	55	62
645	87	90	81	77	72	66	59	51	58
525	82	84	76	71	66	59	52	44	53
430	77	79	70	65	60	53	46	37	47
350	75	67	63	58	52	45	37	29	39

Accessories:

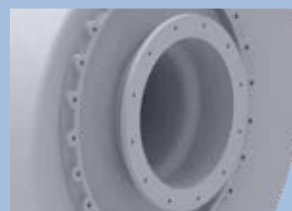

 Protection grid
P. 32

 Shaft seal
P. 34

 Flange connection
P. 34

 Motor cover
P. 35

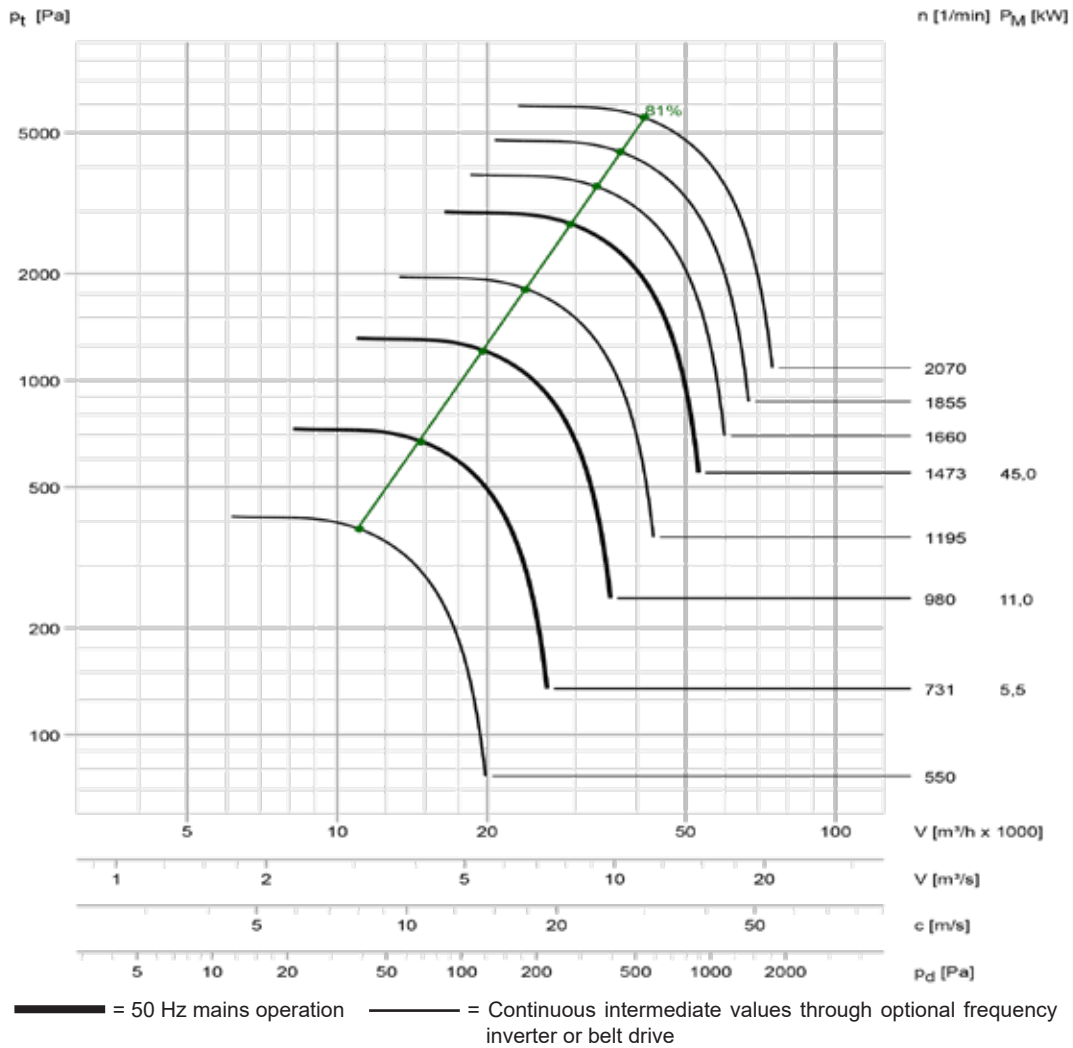
HF R 710-13 D / R

Impeller made of FRP | Carbon | Steel



Acoustic level according to DIN 45635									
Speed [1/min]	inlet level / outlet level of the duct sound level non-valuated; Lw3 = Lw4 [dB]								Lp2A (1 m) [dB(A)]
	63	125	250	500	1000	2000	4000	8000	
2070	117	116	115	117	108	104	98	92	93
1855	115	114	112	114	105	100	95	88	90
1660	112	111	109	111	102	97	91	85	87
1473	108	107	110	102	98	93	87	80	82
1195	103	102	104	96	91	86	80	73	76
980	98	97	99	90	85	80	74	66	71
731	90	93	85	81	76	70	63	55	60
550	83	85	77	72	67	61	54	46	52



Sound enclosure
P. 36



Repair switch
P. 37



Fans optionally available
for Ex-Zone!
P. 48

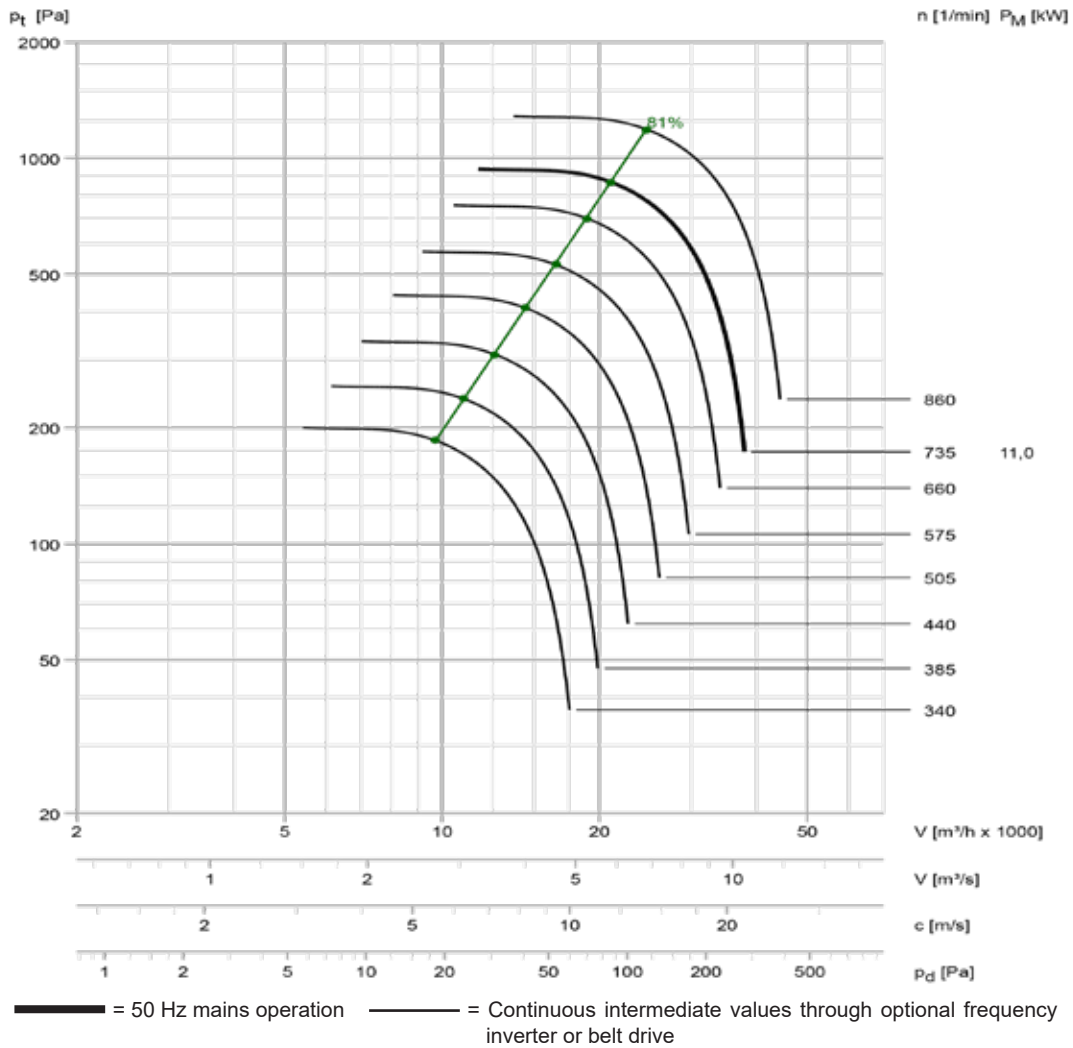

Acoustic level according to DIN 45635									
Speed [1/min]	inlet level / outlet level of the duct sound level non-valuated; Lw3 = Lw4 [dB]								Lp2A (1 m) [dB(A)]
	63	125	250	500	1000	2000	4000	8000	
860	99	97	99	91	86	80	73	66	72
735	95	97	89	85	80	74	67	60	65
660	92	94	86	82	77	71	64	56	62
575	88	91	82	78	73	66	59	51	59
505	85	87	79	74	69	62	55	47	55
440	82	84	75	70	65	58	51	42	51
385	82	74	70	65	59	52	45	36	45
340	79	70	66	61	55	48	41	32	41

Accessories:

 Protection grid
P. 32

 Shaft seal
P. 34

 Flange connection
P. 34

 Motor cover
P. 35

HF R 800-13 D / R

Impeller made of FRP | Carbon | Steel

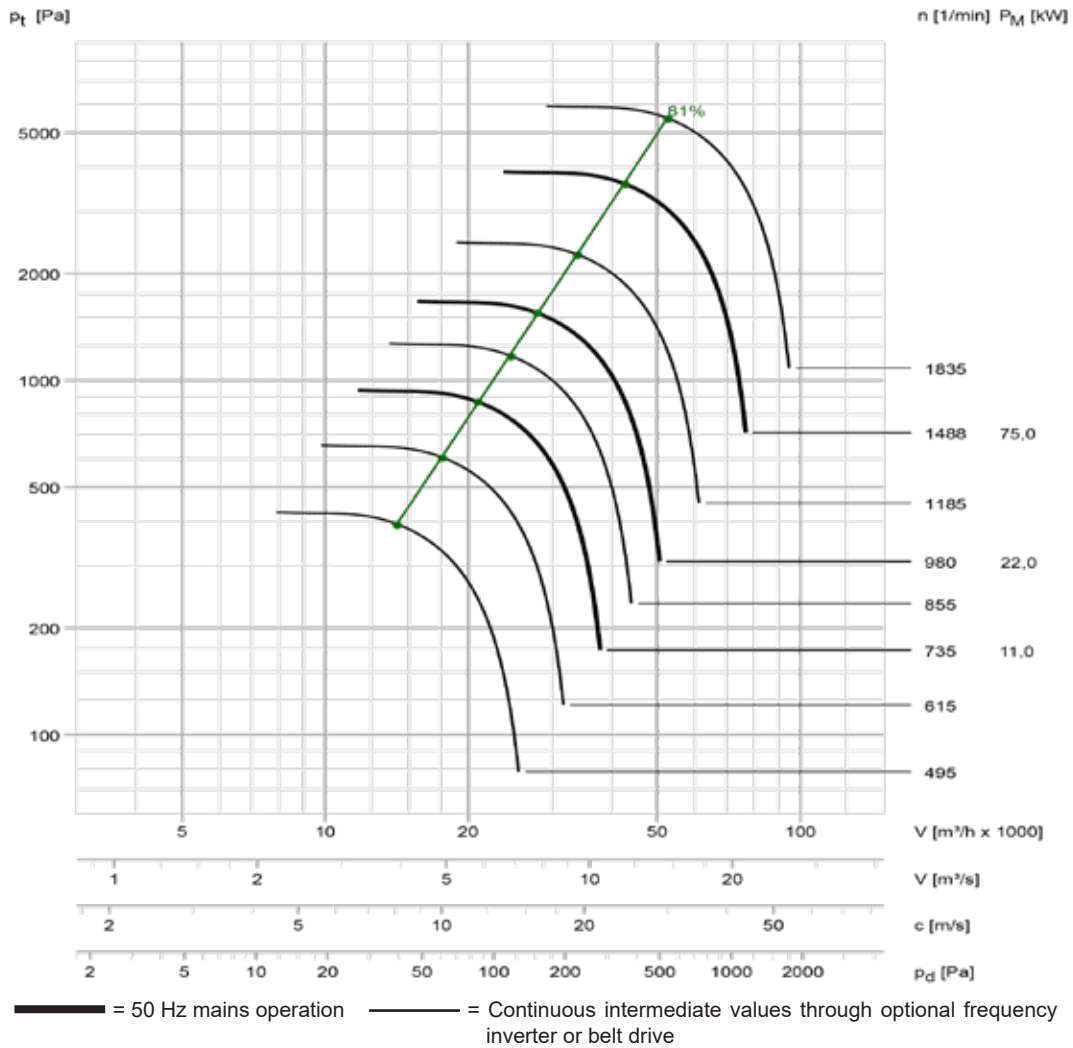

Acoustic level according to DIN 45635									
Speed [1/min]	inlet level / outlet level of the duct sound level non-valuated; Lw3 = Lw4 [dB]								Lp2A (1 m) [dB(A)]
	63	125	250	500	1000	2000	4000	8000	
1835	119	118	116	118	109	104	99	92	93
1488	113	112	114	106	102	97	91	84	86
1185	107	106	108	100	95	90	84	77	80
980	103	101	103	94	90	84	78	70	74
855	99	97	99	90	86	80	73	66	70
735	95	97	89	85	80	74	67	60	64
615	90	93	84	80	75	69	62	54	59
495	85	87	78	74	68	62	54	46	53



Sound enclosure
P. 36



Repair switch
P. 37



Fans optionally available
for Ex-Zone!
P. 48

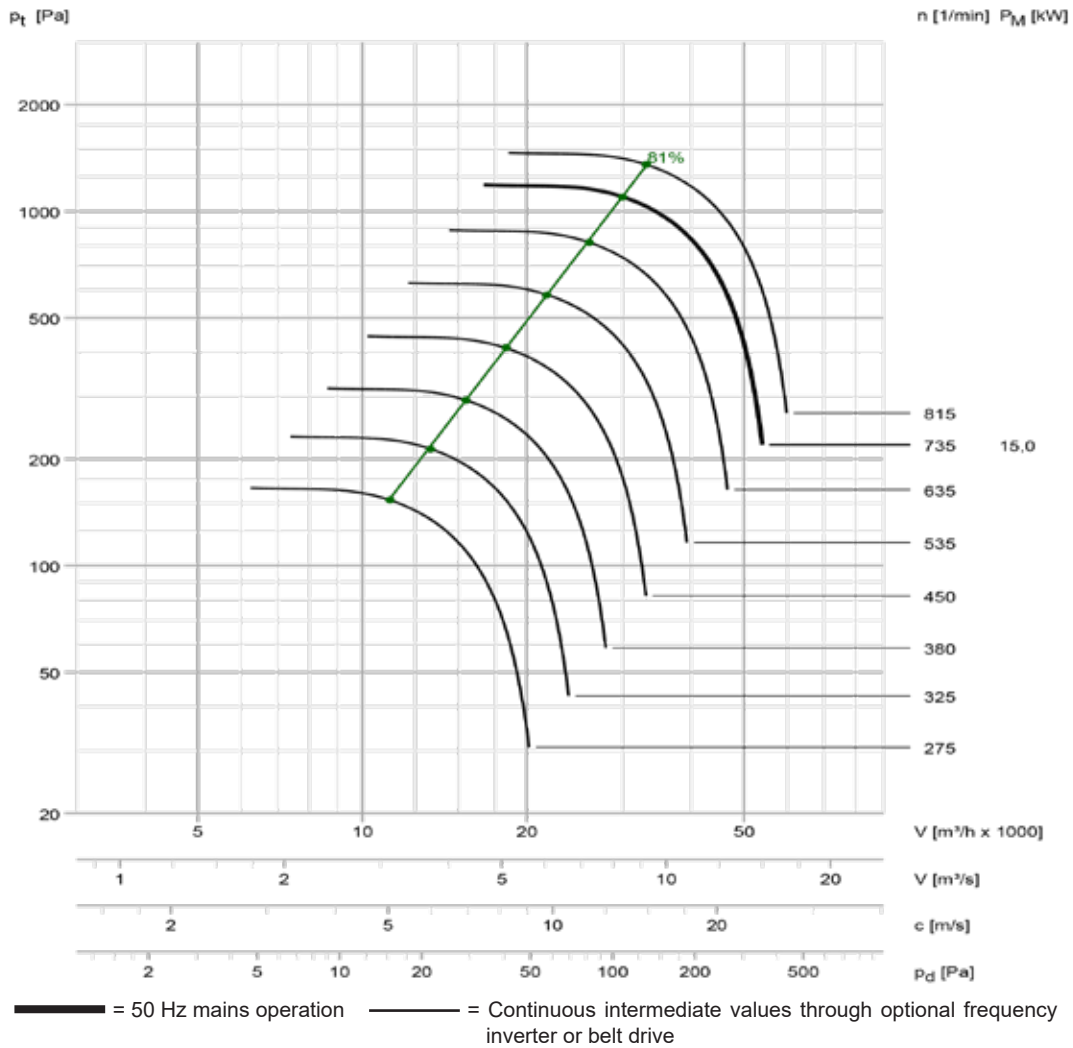

Acoustic level according to DIN 45635									
Speed [1/min]	inlet level / outlet level of the duct sound level non-valuated; Lw3 = Lw4 [dB]								Lp2A (1 m) [dB(A)]
	63	125	250	500	1000	2000	4000	8000	
815	102	100	102	93	88	82	76	68	74
735	99	101	93	89	84	78	71	64	69
635	95	98	89	85	80	74	67	59	65
535	91	93	84	80	75	68	61	53	60
450	86	88	80	75	69	63	55	47	55
380	86	78	74	69	63	56	48	40	48
325	82	73	69	64	58	51	43	34	44
275	77	69	64	59	53	46	37	29	39

Accessories:

 Protection grid
P. 32

 Shaft seal
P. 34

 Flange connection
P. 34

 Motor cover
P. 35

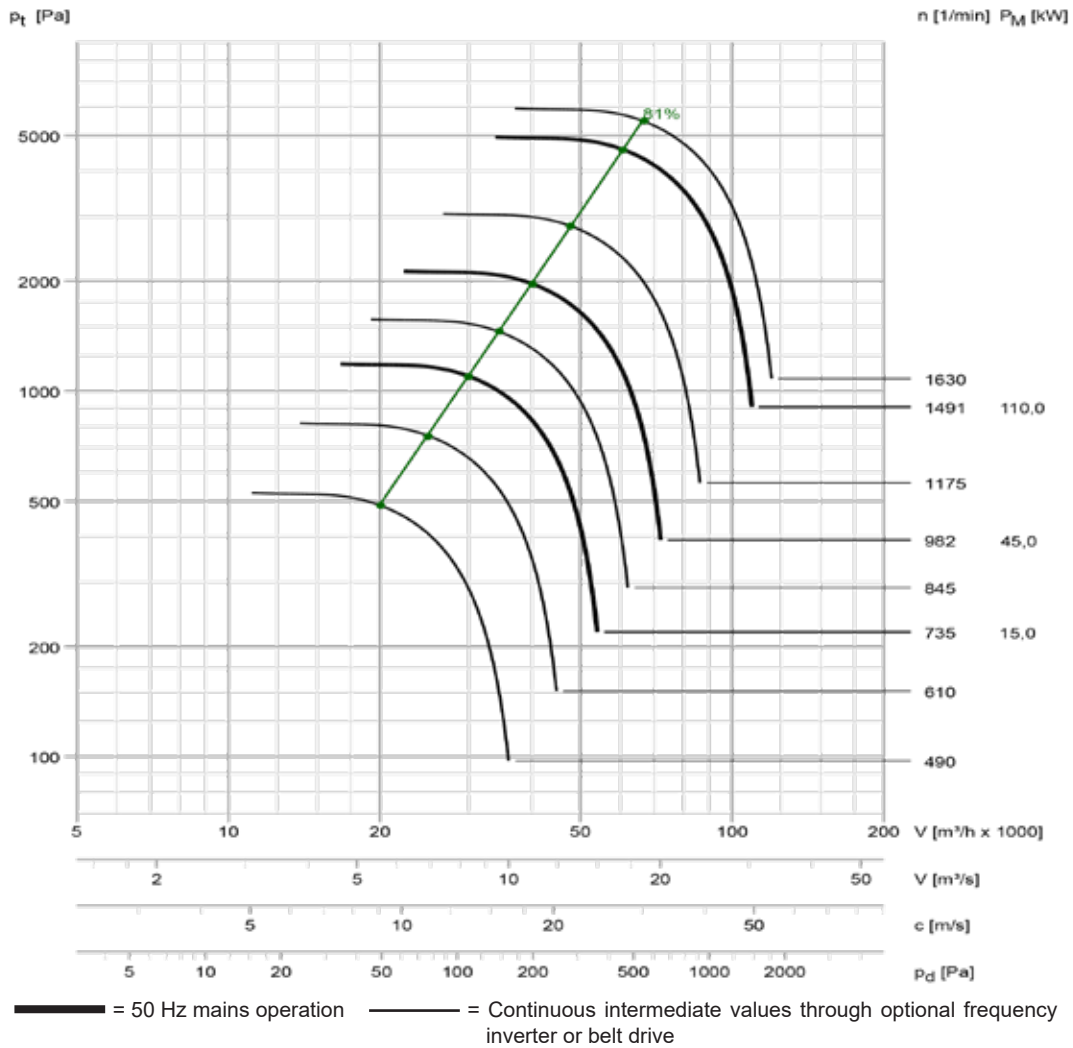

Acoustic level according to DIN 45635									
Speed [1/min]	inlet level / outlet level of the duct sound level non-valuated; Lw3 = Lw4 [dB]								Lp2A (1 m) [dB(A)]
	63	125	250	500	1000	2000	4000	8000	
1630	120	119	116	118	110	105	99	92	93
1491	117	116	118	110	106	101	95	89	90
1175	111	110	112	104	99	94	88	81	83
982	107	105	107	98	94	88	82	75	78
845	103	101	103	94	89	84	77	69	74
735	99	101	93	89	84	78	71	64	68
610	94	96	88	84	79	72	65	57	63
490	88	91	82	77	72	65	58	50	56



Sound enclosure
P. 36



Repair switch
P. 37



Fans optionally available
for Ex-Zone!
P. 48

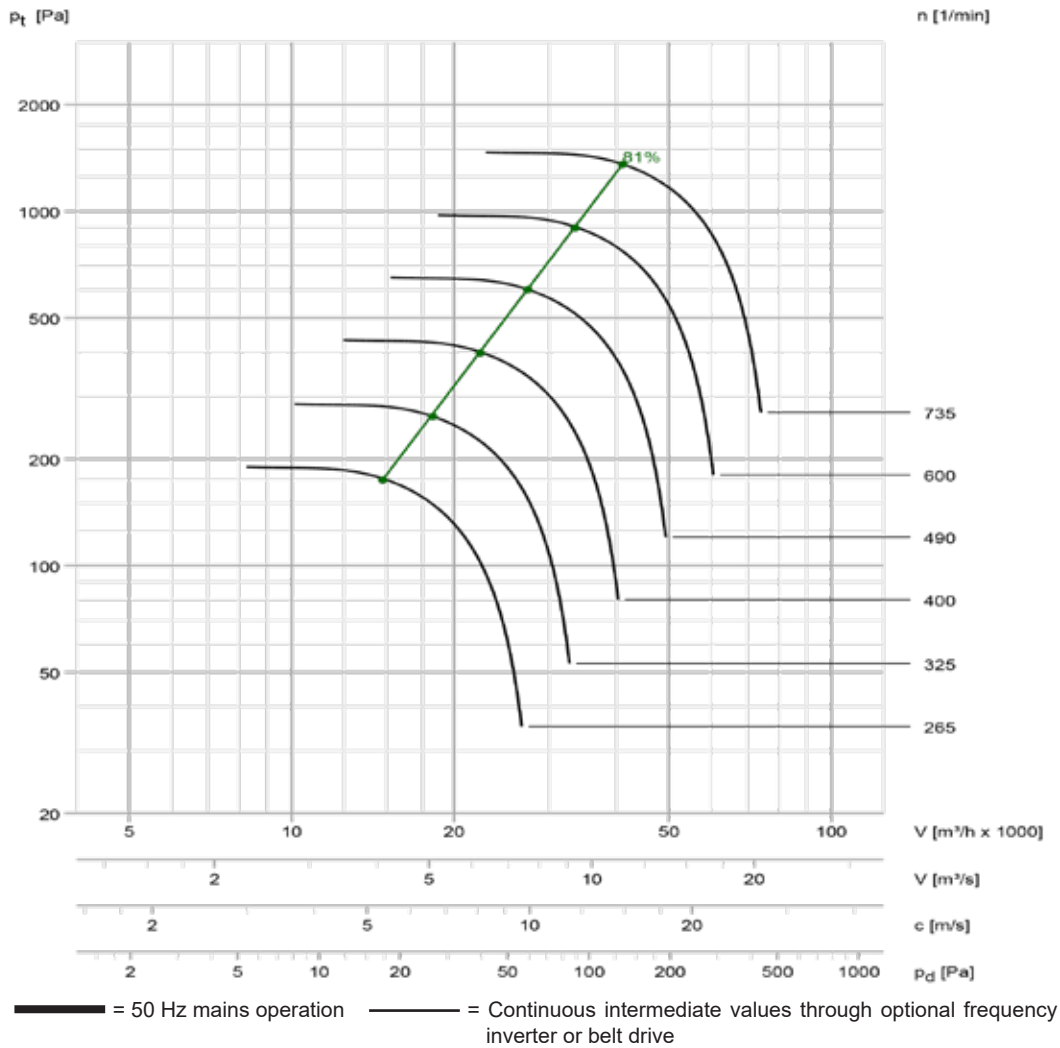

Acoustic level according to DIN 45635									
Speed [1/min]	inlet level / outlet level of the duct sound level non-valuated; Lw3 = Lw4 [dB]								Lp2A (1 m) [dB(A)]
	63	125	250	500	1000	2000	4000	8000	
735	102	105	97	93	88	82	75	67	72
600	97	100	91	87	82	76	68	61	66
490	92	94	86	81	76	69	62	54	60
400	87	89	80	75	69	63	55	47	55
325	85	77	73	68	62	55	47	38	46
265	80	71	67	62	55	48	40	31	40

Accessories:

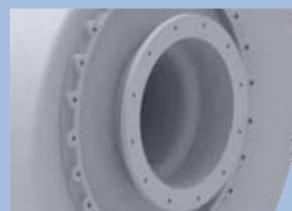

 Protection grid
P. 32

 Shaft seal
P. 34

 Flange connection
P. 34

 Motor cover
P. 35

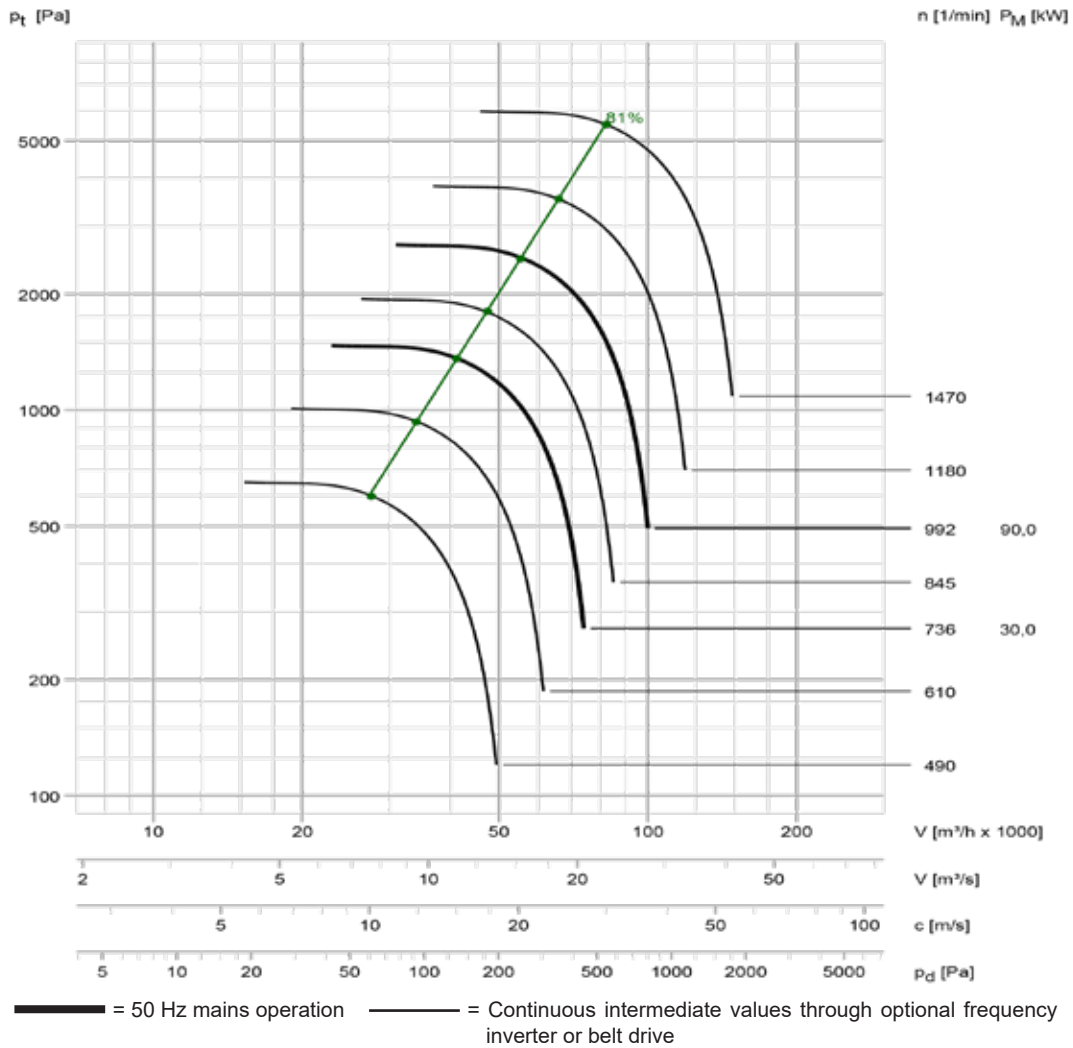
HF R 1000-13 D / R

Impeller made of FRP | Carbon | Steel



Acoustic level according to DIN 45635									
Speed [1/min]	inlet level / outlet level of the duct sound level non-valuated; Lw3 = Lw4 [dB]								Lp2A (1 m) [dB(A)]
	63	125	250	500	1000	2000	4000	8000	
1470	120	119	122	114	109	105	99	92	92
1180	115	113	116	107	103	98	92	84	86
992	111	109	111	102	98	92	86	79	81
845	107	105	107	98	93	87	81	73	77
736	102	105	97	93	88	82	75	68	71
610	98	100	92	87	82	76	69	61	66
490	92	94	86	81	76	69	62	54	60



Sound enclosure
P. 36



Repair switch
P. 37



Fans optionally available
for Ex-Zone!
P. 48

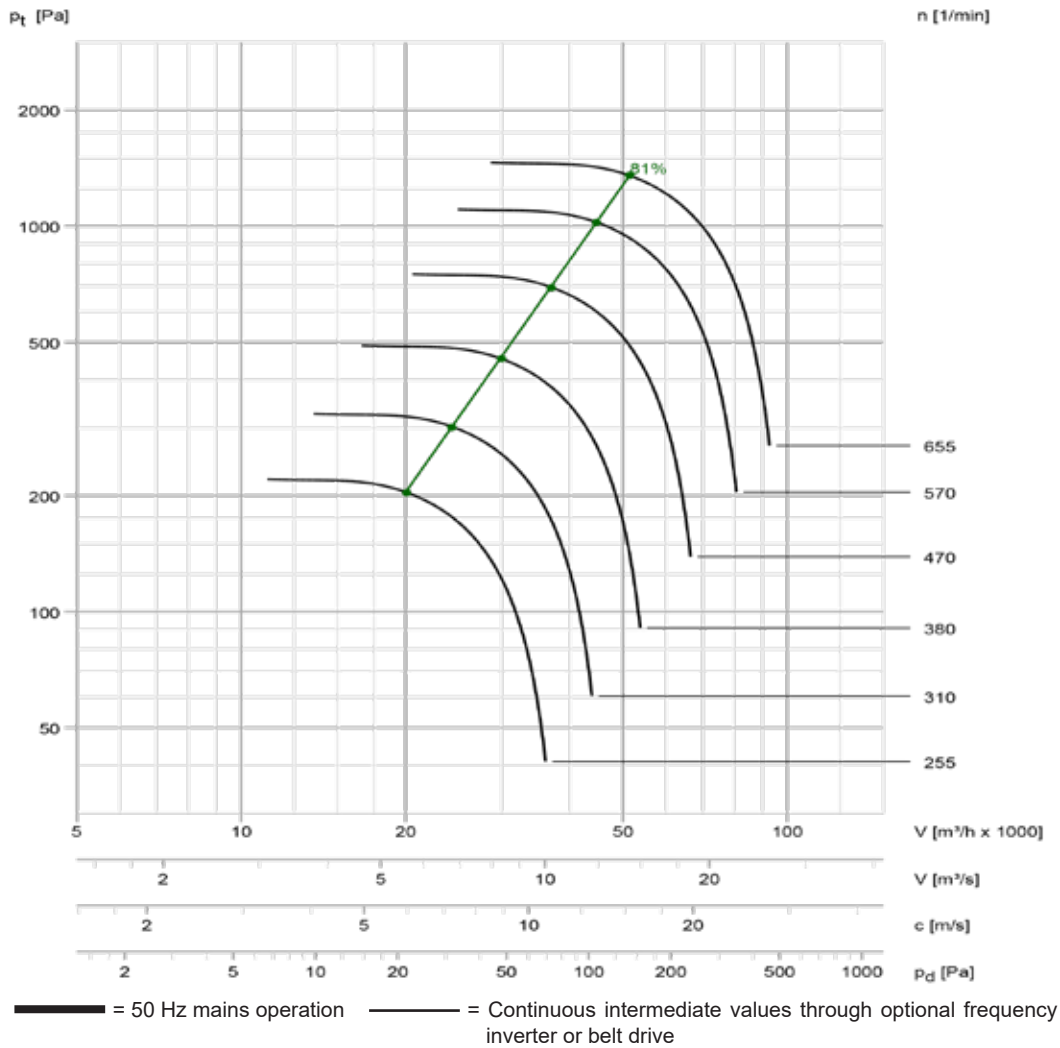

Acoustic level according to DIN 45635									
Speed [1/min]	inlet level / outlet level of the duct sound level non-valuated; Lw3 = Lw4 [dB]								Lp2A (1 m) [dB(A)]
	63	125	250	500	1000	2000	4000	8000	
655	103	106	98	93	88	82	75	67	72
570	100	102	94	89	84	78	71	63	68
470	95	97	88	84	78	72	64	56	62
380	93	85	81	76	70	64	56	47	54
310	88	80	75	70	64	57	49	40	48
255	83	74	70	64	58	51	43	33	43

Accessories:

 Protection grid
P. 32

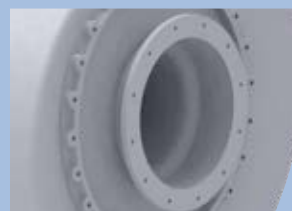
 Shaft seal
P. 34

 Flange connection
P. 34

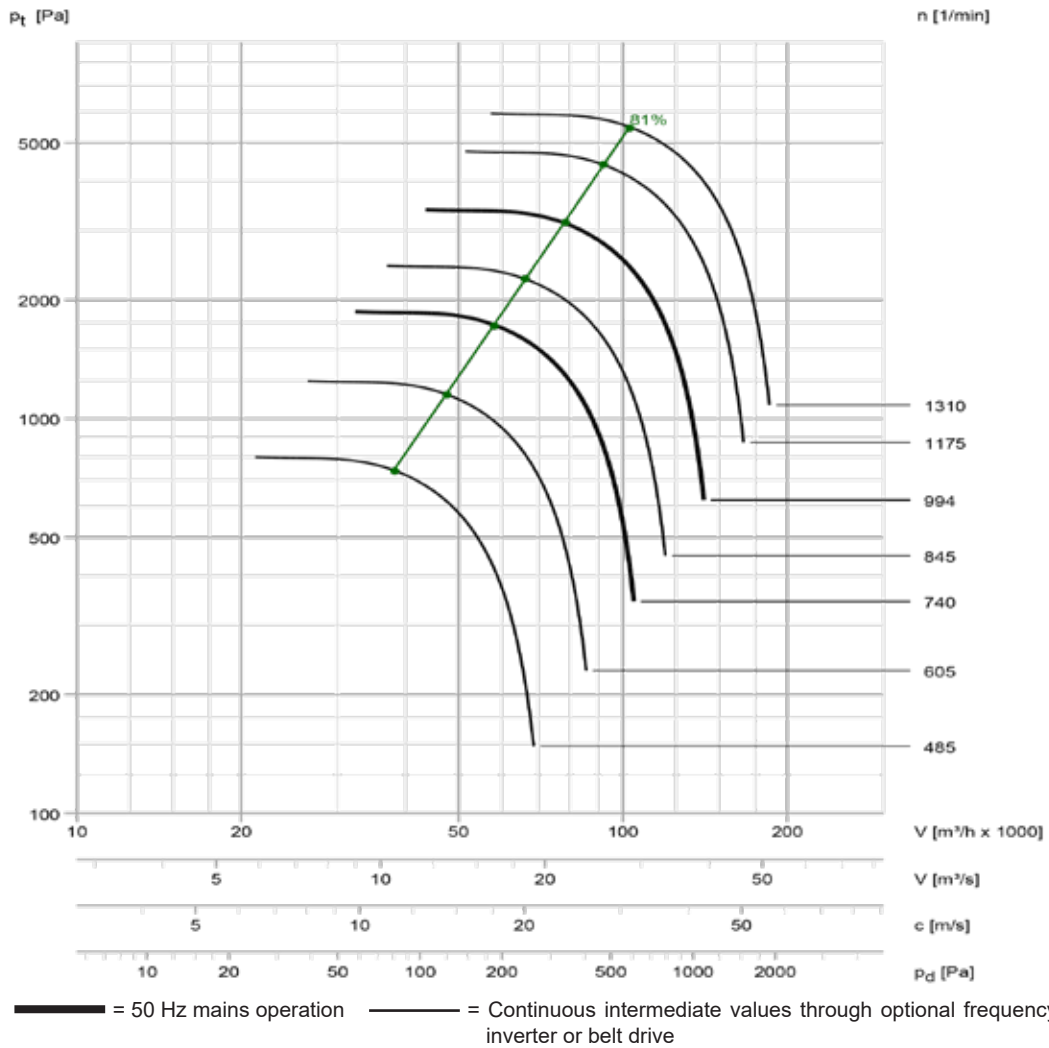
 Motor cover
P. 35



Acoustic level according to DIN 45635									
Speed [1/min]	inlet level / outlet level of the duct sound level non-valuated; Lw3 = Lw4 [dB]								Lp2A (1 m) [dB(A)]
	63	125	250	500	1000	2000	4000	8000	
1310	121	120	123	114	110	105	99	92	92
1175	119	117	120	111	107	102	95	88	89
994	115	113	115	106	102	96	90	83	85
845	111	109	111	102	97	91	85	77	80
740	106	109	101	97	92	86	79	72	74
605	101	104	95	91	86	80	73	65	69
485	96	98	89	85	79	73	65	57	63



Sound enclosure
P. 36



Repair switch
P. 37



Fans optionally available
for Ex-Zone!
P. 48

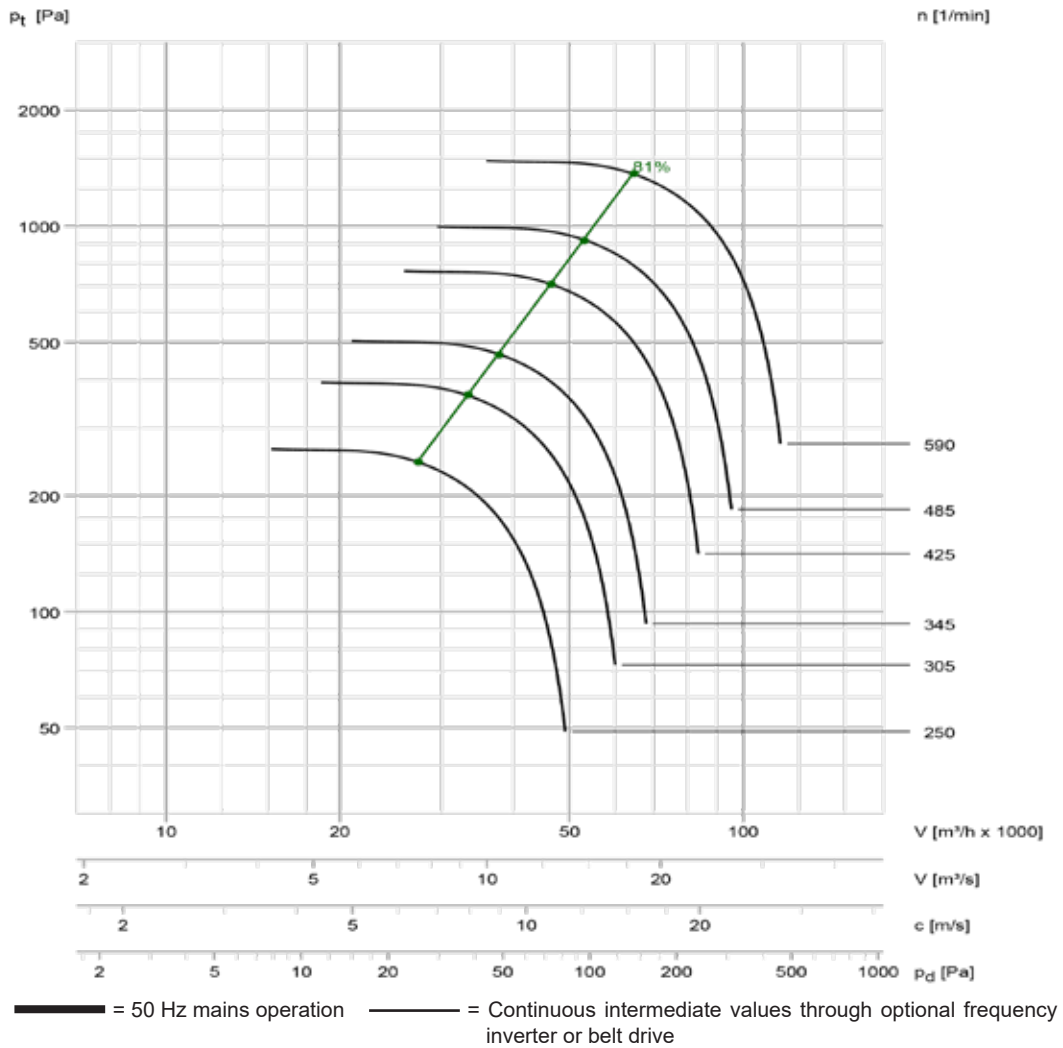

Acoustic level according to DIN 45635									
Speed [1/min]	inlet level / outlet level of the duct sound level non-valuated; Lw3 = Lw4 [dB]								Lp2A (1 m) [dB(A)]
	63	125	250	500	1000	2000	4000	8000	
590	105	107	99	94	89	83	76	68	72
485	400	102	93	89	83	77	69	61	67
425	96	98	90	85	79	72	65	57	63
345	95	86	82	77	71	64	57	48	55
305	91	83	79	74	67	60	52	44	51
250	86	78	73	68	61	54	46	37	45

Accessories:

 Protection grid
P. 32

 Shaft seal
P. 34

 Flange connection
P. 34

 Motor cover
P. 35

HF R 1250-13 D / R

Impeller made of FRP | Carbon | Steel

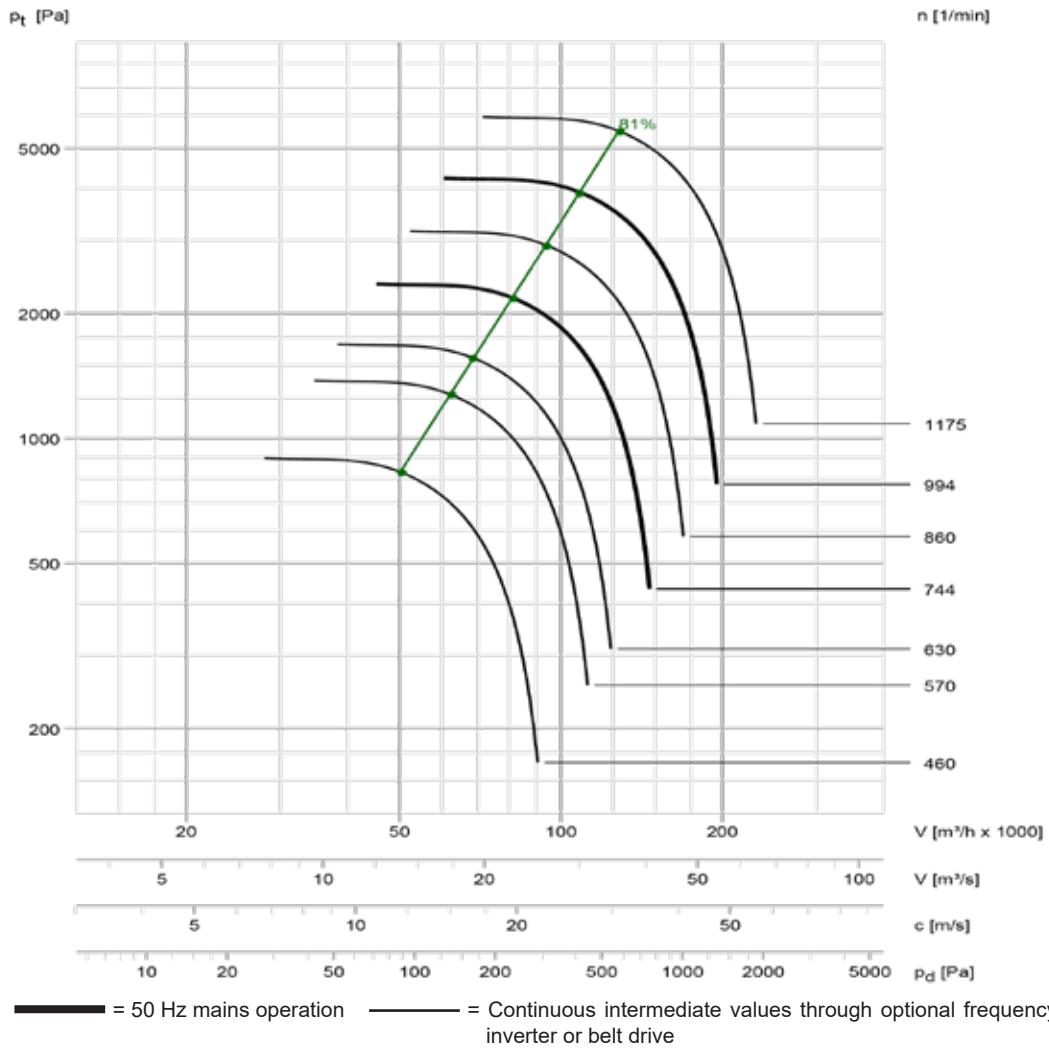

Acoustic level according to DIN 45635									
Speed [1/min]	inlet level / outlet level of the duct sound level non-valuated; Lw3 = Lw4 [dB]								Lp2A (1 m) [dB(A)]
	63	125	250	500	1000	2000	4000	8000	
1175	123	121	123	115	111	105	99	92	93
994	119	117	119	110	106	100	94	86	88
860	115	113	115	106	101	96	89	82	84
744	110	113	105	101	96	90	83	76	78
630	106	109	100	96	91	85	78	70	73
570	104	106	98	93	88	82	75	67	70
460	98	100	92	87	81	75	68	59	64



Sound enclosure
P. 36



Repair switch
P. 37



Fans optionally available
for Ex-Zone!
P. 48

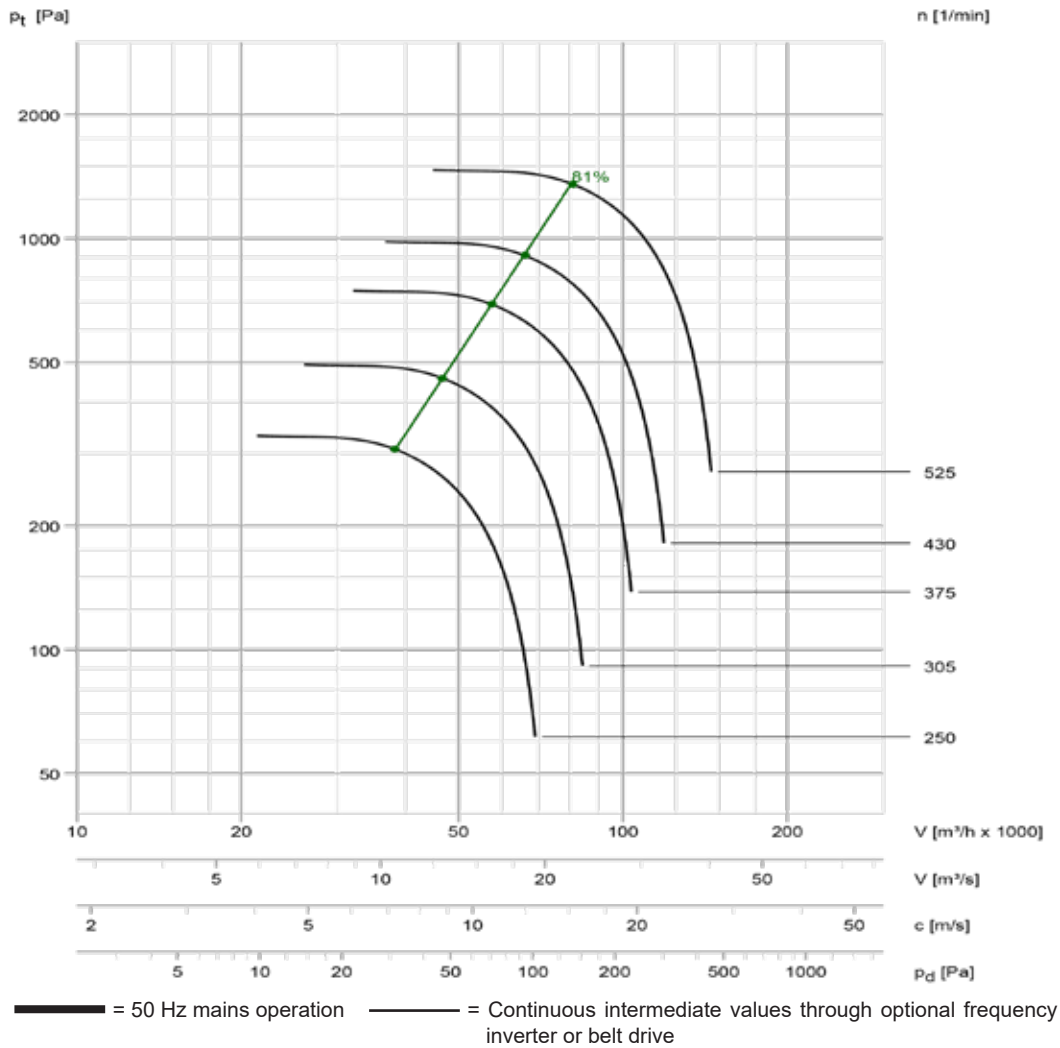

Acoustic level according to DIN 45635									
Speed [1/min]	inlet level / outlet level of the duct sound level non-valuated; Lw3 = Lw4 [dB]								Lp2A (1 m) [dB(A)]
	63	125	250	500	1000	2000	4000	8000	
525	106	108	99	95	89	83	76	68	72
430	101	103	94	89	83	77	69	61	67
375	101	93	89	84	78	71	63	55	60
305	95	87	83	77	71	64	56	48	54
250	90	82	77	72	65	58	50	41	49

Accessories:

 Protection grid
P. 32

 Shaft seal
P. 34

 Flange connection
P. 34

 Motor cover
P. 35

HF R 1400-13 D / R

Impeller made of FRP | Carbon | Steel

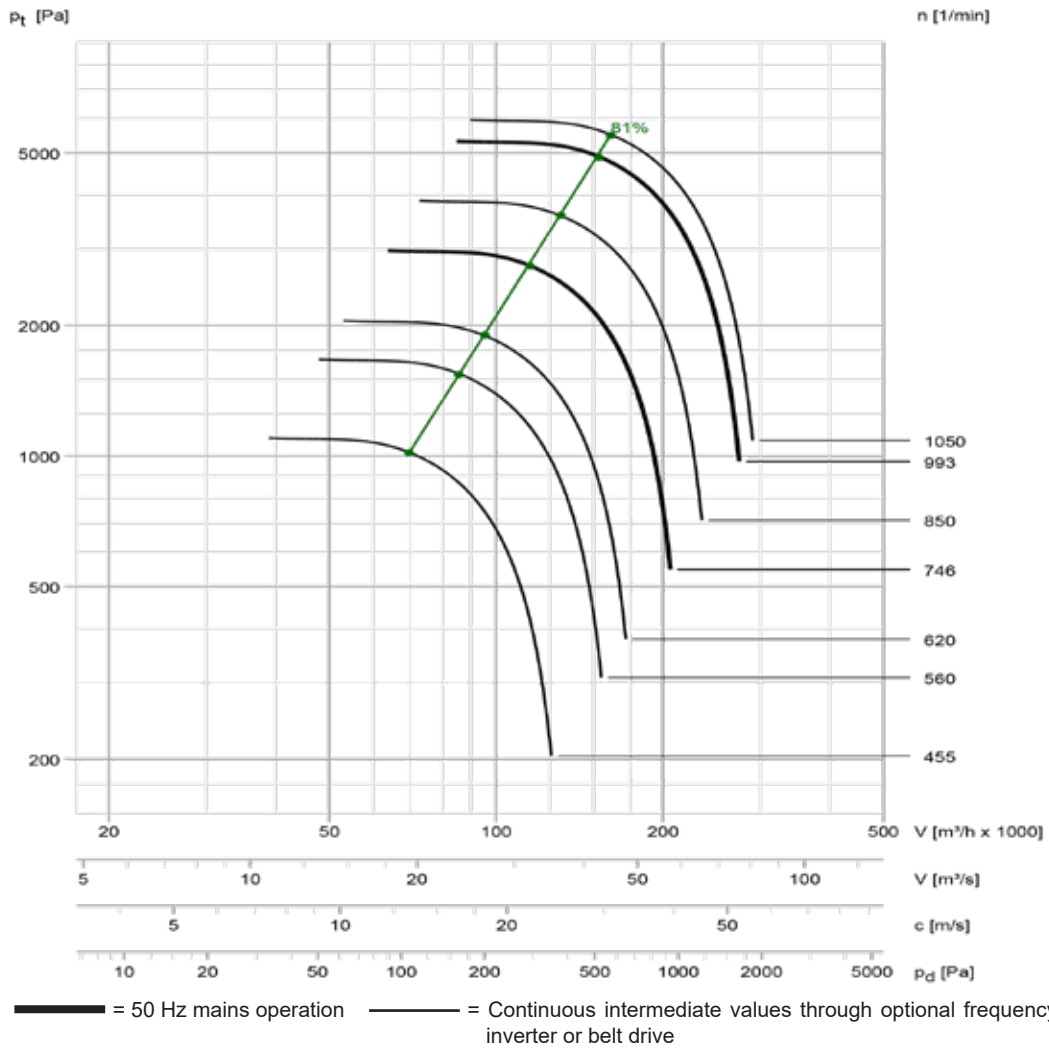

Acoustic level according to DIN 45635									
Speed [1/min]	inlet level / outlet level of the duct sound level non-valuated; Lw3 = Lw4 [dB]								Lp2A (1 m) [dB(A)]
	63	125	250	500	1000	2000	4000	8000	
1050	124	122	124	116	111	106	99	92	93
993	122	121	123	114	110	104	98	90	91
850	119	117	119	110	105	99	93	85	87
746	114	117	109	105	100	94	87	80	81
620	110	112	104	100	94	88	81	73	76
560	107	110	101	97	91	85	78	70	73
455	102	104	95	91	85	79	71	63	67



Sound enclosure
P. 36



Repair switch
P. 37



Fans optionally available
for Ex-Zone!
P. 48

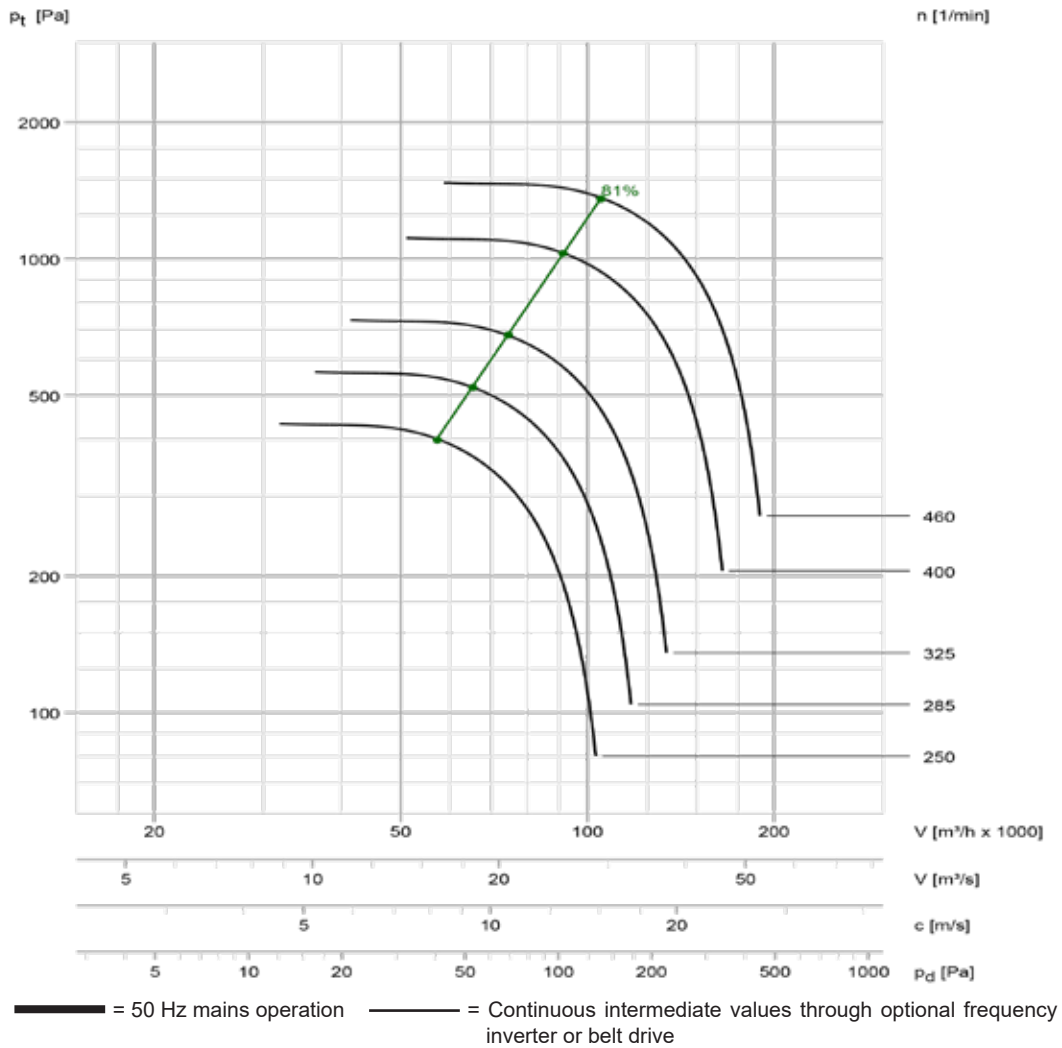

Acoustic level according to DIN 45635									
Speed [1/min]	inlet level / outlet level of the duct sound level non-valuated; Lw3 = Lw4 [dB]								Lp2A (1 m) [dB(A)]
	63	125	250	500	1000	2000	4000	8000	
460	107	109	100	96	90	84	76	68	72
400	103	105	96	92	86	79	72	63	68
325	102	93	89	84	78	71	63	54	60
285	98	90	85	80	74	67	59	50	56
250	95	86	82	76	70	63	54	45	53

Accessories:

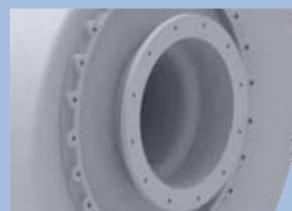

 Protection grid
P. 32

 Shaft seal
P. 34

 Flange connection
P. 34

 Motor cover
P. 35

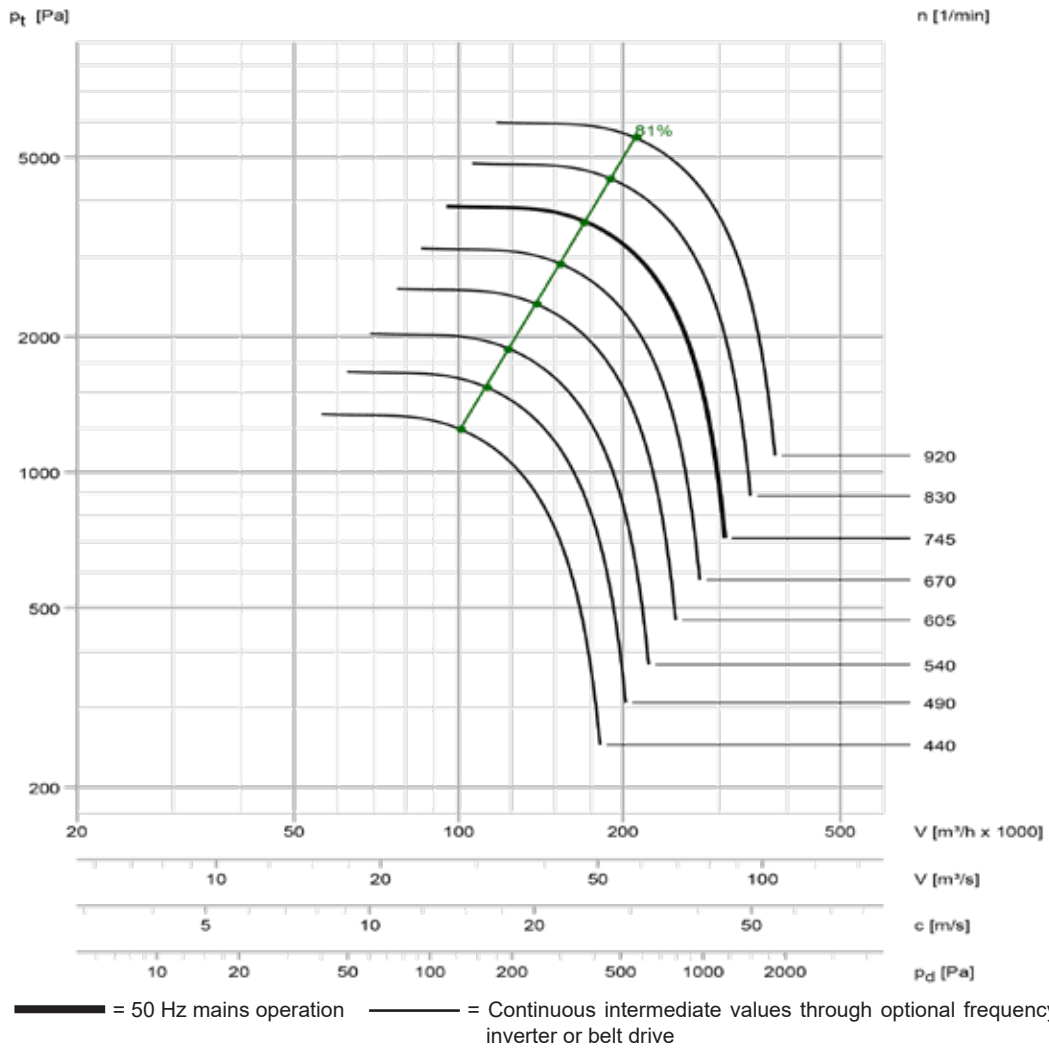
HF R 1600-13 D / R

Impeller made of FRP | Carbon | Steel



Acoustic level according to DIN 45635									
Speed [1/min]	inlet level / outlet level of the duct sound level non-valuated; Lw3 = Lw4 [dB]								Lp2A (1 m) [dB(A)]
	63	125	250	500	1000	2000	4000	8000	
920	125	123	125	117	112	106	100	92	93
830	123	121	123	114	109	103	96	89	90
745	119	122	114	110	105	99	92	84	85
670	116	119	111	107	101	95	89	81	82
605	114	116	108	104	98	92	85	77	79
540	111	113	105	100	95	89	81	73	76
490	109	111	102	97	92	86	78	70	73
440	106	108	99	94	89	82	75	66	70



Sound enclosure
P. 36



Repair switch
P. 37



Fans optionally available
for Ex-Zone!
P. 48

Accessories for
HF - Centrifugal fans
Type series HF R ...-13 D / R

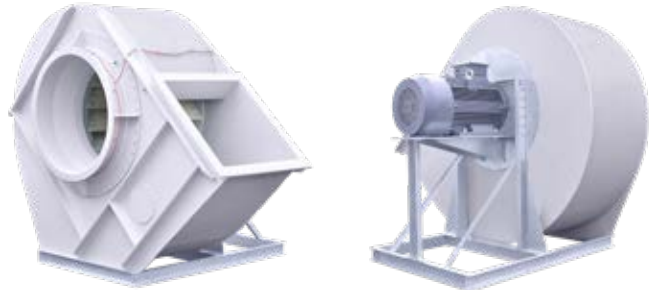

Vibration dampers

Protect against vibrations

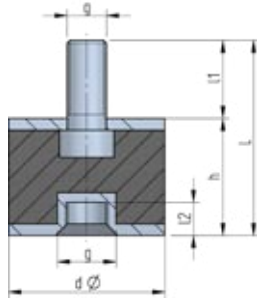

Ø	h	g	L	l1	l2
15	15	M4	28	13	8
20	15	M6	30	15	6
30	30	M8	50	20	8
40	30	M8	54	24	8
50	30	M10	64	34	8
70	45	M10	70	25	8
100	40	M16	83	43	16

Protection grid

Protects against foreign bodies



Size	Inlet side	Outlet side
Ø	Article no.	Article no.
450	441-020-450002	441-021-450002
500	441-020-500004	441-021-500003
560	441-020-560000	441-021-560000
630	441-020-630000	441-021-630000
710	441-020-710000	441-021-710000
800	441-020-800000	441-021-800000
900	441-020-900000	441-021-900000
1000	441-020-100000	441-021-100000
1120	441-020-112000	441-021-112000
1250	441-020-125004	441-021-125004
1400		
1600		



Accessories for
HF - Centrifugal fans
Type series HF R ...-13 D / R

Shaft seal Kera/Viton

Protects against leakage at the shaft passage



High-quality sealing system with lip seal made of fluoroelastomer and highly corrosion-resistant Kera shaft sleeve (duroplastic phenolic resin reinforced with carbon fibres). Resistant to all inorganic acids, alkalis and hydrocarbons commonly used in chemical plant construction, including hydrogen fluoride (HF). Surface antistatic <math>< 10^{-5}</math> ohms.

- High sealing requirements

Shaft seal Hastelloy/Viton

Protects against leakage at the shaft passage



High-quality sealing system with lip seal made of fluororubber and shaft sleeve made of highly corrosion-resistant nickel-based alloy. Resistant to all inorganic acids, alkalis and hydrocarbons commonly used in chemical plant construction. Highly suitable for wet media.

- High sealing requirements

Shaft seal TopSealed Hastelloy

Protects against leakage at the shaft passage



Multi-stage sealing system. Intermediate space with suction return to the fan suction nozzle to prevent the medium from escaping in the direction of the atmosphere. Optionally available with connection for on-site sealing gas.

- Very high sealing requirements

Accessories for
HF - Centrifugal fans
Type series HF R ...-13 D / R

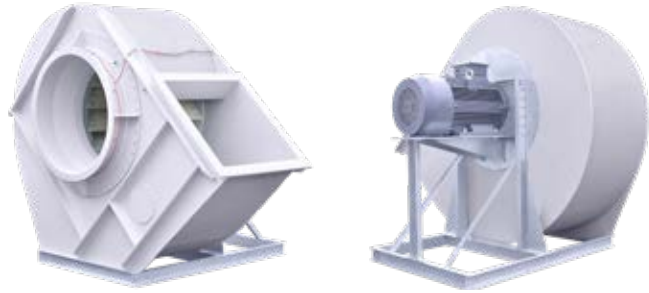

Flange connection

Recommended for higher demands on tightness and at higher pressures

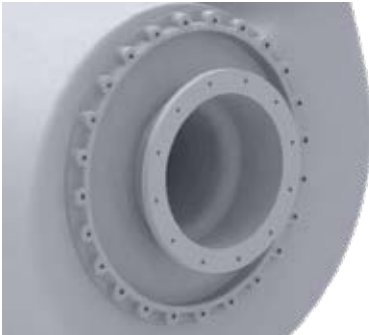

DS1 Size	Inlet side			
	PPs	PP	PVC	PE
Ø	Article no.	Article no.	Article no.	Article no.
450	441-060-450001			
500	441-060-500004			
560	441-060-560001			
630	441-060-630001			
710	441-060-710001			
800	441-060-800001			
900	441-060-900001			
1000	441-060-100001			
1120				
1250				
1400				
1600				

Sleeve with flanges

For flexible connection with higher demands on tightness and at higher pressures



Size	Inlet side		Outlet side	
	DS1	DS2 / DS3	DS1	DS2 / DS3
	PVC	PVC	PVC	PVC
Ø	Article no.	Article no.	Article no.	Article no.
450	441-063-500000	441-063-500001	441-064-500000	441-064-500001
500	441-063-500003	441-063-500004	441-064-500003	441-064-500004
560	441-063-500005	441-063-500006	441-064-500005	441-064-500006
630	441-063-500007	441-063-500008	441-064-500007	441-064-500008
710	441-063-500009	441-063-500010	441-064-500009	441-064-500010
800	441-063-500011	441-063-500012	441-064-500011	441-064-500012
900	441-063-500013	441-063-500014	441-064-500013	441-064-500014
1000	441-063-500015	441-063-500016	441-064-500015	441-064-500016
1120		441-063-500017		441-064-500017
1250		441-063-500018		441-064-500018
1400				
1600				

Accessories



Accessories for
HF - Centrifugal fans
Type series HF R ...-13 D / R

Sleeve with VA tightening straps

For easy flexible connection to duct

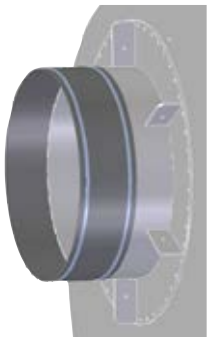

DS1 Size	Inlet side
	PVC
Ø	Article no.
450	441-063-500019
500	441-063-500020
560	441-063-500021
630	441-063-500022
710	441-063-500023
800	441-063-500024
900	441-063-500025
1000	441-063-500026
1120	
1250	
1400	
1600	

Intake manifold



Size	Inlet side
	PPs
Ø	Article no.
450	436-019-300020
500	436-019-300020
560	436-019-300020
630	436-019-300020
710	436-019-300020
800	436-019-300020
900	436-019-300020
1000	436-019-300020
1120	
1250	
1400	
1600	

Accessories for
HF - Centrifugal fans
Type series HF R ...-13 D / R

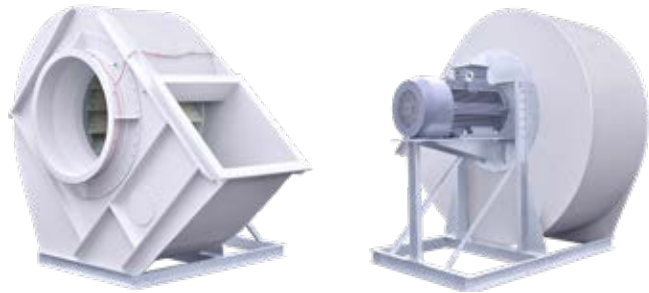

Motor cover

Protects the electric motor from weather influences

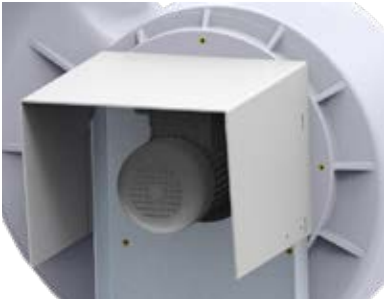

Three-sided cover to protect against the weather, recommended for the outdoor installation of fans. Protects the motor and wiring against rain and UV radiation.

Standard material as housing material, also available in galvanised or powder-coated metal.

Sound enclosure

Reduces the sound radiation of the fan



Version in steel, galvanised:

- Frame construction with panels for easy access via turning bolt
- Suitable for outdoor installation
- Supply and exhaust air grille for self-ventilation with damped openings
- The scope of delivery includes bushings for air ducts, condensate drain, electro cables as well as lifting lugs and mounting profiles for steel construction or floor.
- Sound level reduction as standard approx. 14 dB at 250 Hz, versions for higher sound insulation requirements are available as an option

Version in plastic PP:

- Welded construction made of corrosion-resistant plastic twinwall panels
Access via door
- Suitable for outdoor installation
- Inlet and outlet air grille for self-ventilation with damped openings
- Bushings for air ducts, condensate outlets and electric cables are included. Lifting lugs and machine base on option.
- Sound level reduction approx. 10 dB at 250 Hz

Accessories



Accessories for
HF - Centrifugal fans
Type series HF R ...-13 D / R
repair switch | Connecting
diagram

Connecting diagram for standard three-phase motor

Motor cable		Switch Y (400 V)				Switch Δ (230 V)			
Cable no.	Winding	Pin	Motor cable no.	Mains	Pin	Motor cable no.	Mains		
1	U1	L1	-	(L1)	L1	-	(L1)		
2	V1	L2	-	(L2)	L2	-	(L2)		
3	W1	L3	-	(L3)	L3	-	(L3)		
4	U2	T1	1 (U1)	-	T1	1 (U1) + 6 (W2)			
5	V2	T2	2 (V1)	-	T2	2 (V1) + 4 (U2)			
6	W2	T3	3 (W1)	-	T3	3 (W1) + 5 (V2)			
7	PTC	Y-jumper {							
8	PTC	4 (U2)							
		5 (V2)							
		6 (W2)							

Connection diagram for motors with two speeds | separate winding

Motor cable		Connections at repair switch					
Cable no.	Winding	Switch pins			Motor cable no.		
1	U1	on-site connection 380 V 3-phase	← L1	T1 →	1 (U1)	} low speed	
2	V1		← L2	T2 →	2 (V1)		
3	W1		← L3	T3 →	3 (W1)		
4	U2		← 2L1	2T1 →	4 (U2)	} high speed	
5	V2		← 2L2	2T2 →	5 (V2)		
6	W2		← 2L3	2T3 →	6 (W2)		
7	PTC						
8	PTC						

Connection diagram for motors with two speeds | Dahlander pole changing motor

Motor cable		Connections at repair switch					
Cable no.	Winding	Switch pins			Motor cable no.		
1	U1	on-site connection 380 V 3-phase	← L1	T1 →	1 (U1)	} low speed	
2	V1		← L2	T2 →	2 (V1)		
3	W1		← L3	T3 →	3 (W1)		
4	U2		← 2L1	2T1 →	4 (U2)	} high speed U1 - V1 - W1 must be star connected	
5	V2		← 2L2	2T2 →	5 (V2)		
6	W2		← 2L3	2T3 →	6 (W2)		
7	PTC						
8	PTC						

Accessories for
HF - Centrifugal fans
Type series HF R ...-13 D / R

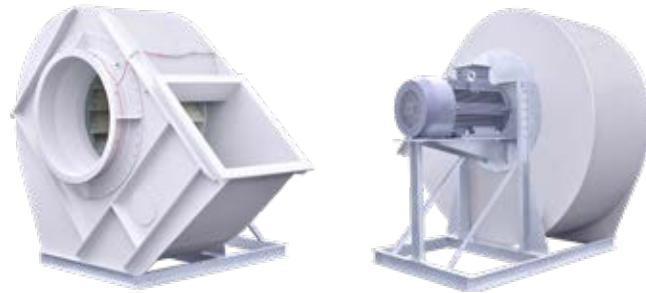

Volume flow measuring device



Features

- Measuring device integrated directly in the fan
- Volume flow measurement through differential pressure
- Determination of the characteristic values at the factory on a standard DIN test bench

Key data

- Available for radial fans in the nominal sizes 125 - 1000 mm connection diameter
- Optionally available with differential pressure transmitter
- Material depends on the fan material

Description of the measuring unit

The measuring device consists of two circuits integrated in the inlet nozzle of the fan.

Positive ring = Red tube
(low negative pressure)

Negative ring = Blue tube
(high netgative pressure)

The differential pressure between the tubes can be used to determine the volume flow via the flow coefficient and the formula below.

The flow coefficient and the necessary sensor range were measured on a factory test bench. The differential pressure sensors must be suitable for the pressure range of the volume flow measuring unit. In order for the device to work properly a straight flow path in length of 3 times the intake diameter of the fan is recommended. Deviations lead to inaccurate measuring results.

Calculation of the volume flow

Formula:

$$\dot{V} = K \cdot \sqrt{\frac{\Delta p}{\rho}}$$

\dot{V} = Volume flow [m³/h]

K = Flow coefficient

Δp = Diff. pressure [Pa]

ρ = Density [kg/m³]



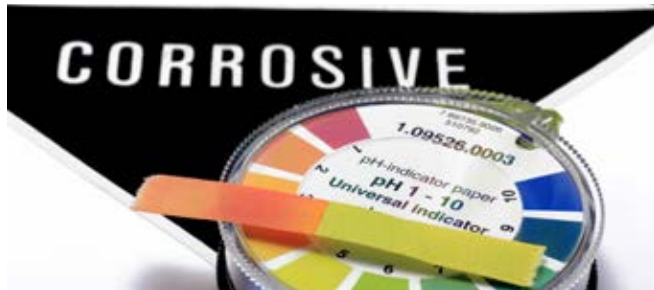

Thermoplastic
Fibre-reinforced plastic
Plastic-coated steel

Plastic

- Durable
- Corrosion resistant
- Resistant to chemicals
- High ductility
- Wide spectrum of materials

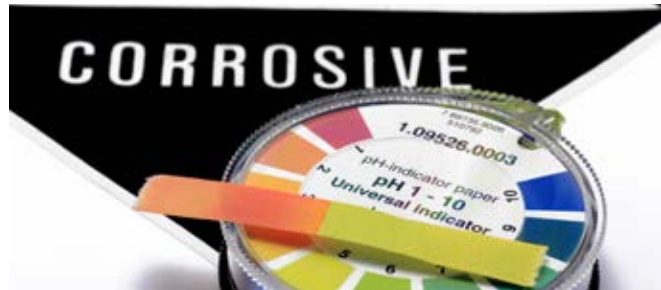

Thermoplastic

**PE**Standard colour
RAL 9005**PEs**Sintered
housing
Standard colour
RAL 7036**Polyethylene | PE****Polyethylene flame retardant | PEs****Features**

- ✓ Good resistance to inorganic acids
 - ✓ High UV resistance
 - ✓ Good low temperature impact resistance
 - ✓ Attractive price
- PEs: Standard material for sintered housings

PPStandard colour
RAL 7032**PPs**Standard colour
RAL 7037**Polypropylene | PP****Polypropylene flame retardant | PPs****Features**

- ✓ Good resistance to inorganic acids
 - ✓ Good mechanical strength
 - ✓ Attractive price
- PPs: Standard material for thermoplastic impellers

PPs-elStandard colour
black**Polypropylene flame-retardant,
electrically conductive | PPs-el****Features**

- ✓ Good resistance to inorganic acids
- ✓ Suitable for ATEX zone 1

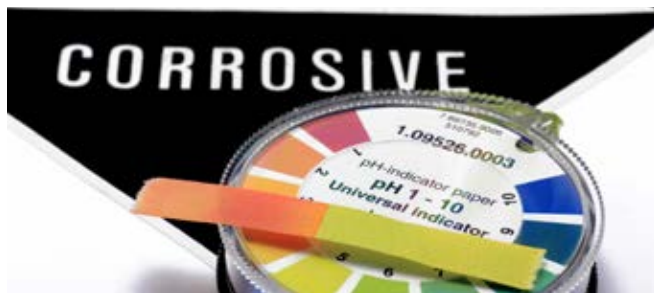

Thermoplastic

PVC

Standard colour
RAL 7011

Polyvinyl chloride | PVC

Features

- ✓ Very good resistance to many chemicals (e.g. chromic acid, chlorine, ozone)
- ✓ Attractive price
- ✓ Can be glued

PVDF

Standard colour
white (natural)

Polyvinylidene fluoride | PVDF

Features

- ✓ Very high chemical resistance
- ✓ High thermal resistance (up to 100 °C)

Fibre-reinforced plastic



Features

- Fibre-plastic composite consisting of a synthetic material and glass fibres. Vinyl ester resins which, when cured, form thermosetting plastics of high strength and chemical resistance are used as standard.

Advantages

- Corrosion-free in highly aggressive environments
- UV and weather resistant
- Long service life
- Inexpensive fibre-reinforced material
- Low specific weight
- Outstanding weight-specific strength
- No plastic deformation, high fatigue strength
- Self-extinguishing, does not drip in case of fire
- Cold and heat resistant
- Available in an electrically conductive version for zone 1

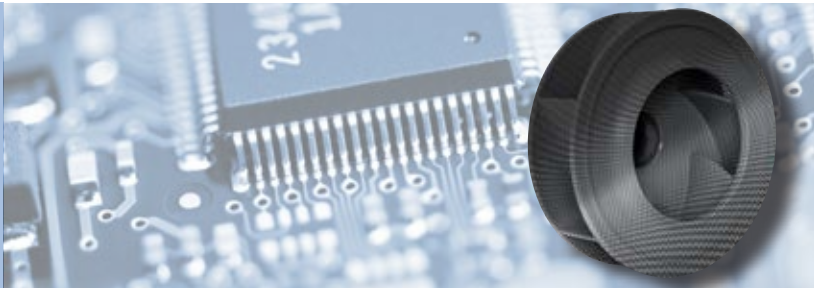

Fibre-reinforced plastic

Carbon fibre reinforced plastic - Carbon | CFRP

The material CFRP is obtained by embedding carbon fibres in a plastic matrix. The matrix, which consists of synthetic resin, thermosets or thermoplastics, for example, firmly bonds the carbon fibres together.

Thanks to its weight advantage in conjunction with its high strength and corrosion-resistant properties, carbon is the material for the highest standards of resistance and strength.

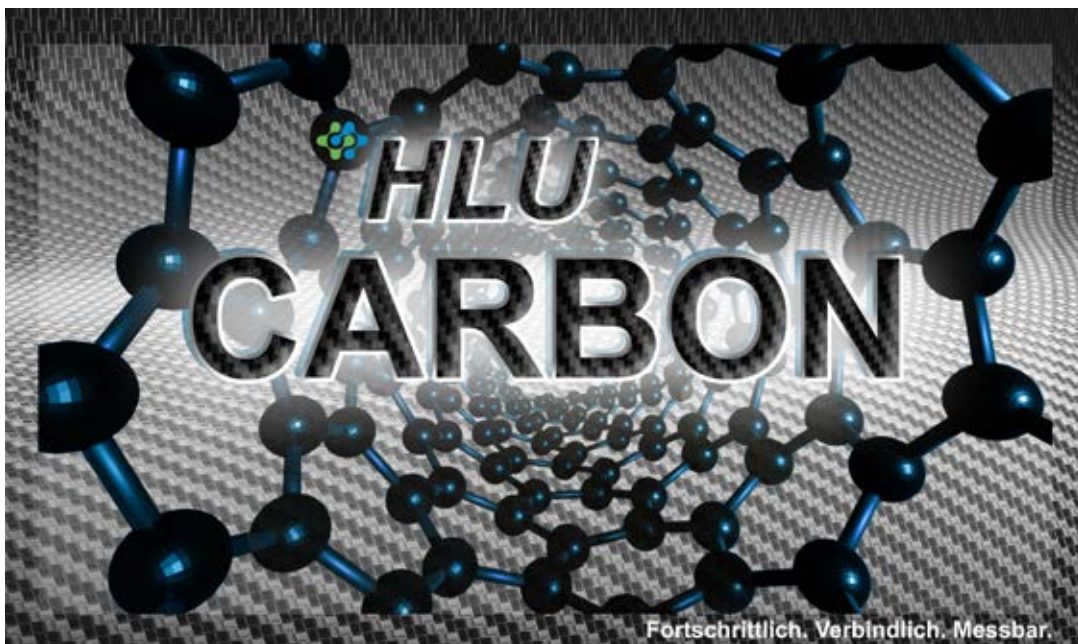

Features

- Fibre-plastic composite consisting of a synthetic material and glass fibres.
Vinyl ester resins which, when cured, form thermosetting plastics of high strength and chemical resistance are used as standard.

Advantages

- Corrosion-free in highly aggressive environments, even with hydrofluoric acid (HF)
- UV and weather resistant
- Long service life
- Very high tensile and compressive strength
- Low specific weight
- Very good dynamic behaviour for very high circumferential speeds
- Self-extinguishing, does not drip in case of fire
- Cold and heat resistant
- Available in an electrically conductive version for zone 1

Steel impellers with coating



Features

- Impellers made of steel materials with chemically resistant coating. The use of different coating materials makes it possible to adapt the impellers to the operating conditions.
- Outstanding corrosion protection
- High temperature resistance
- High chemical resistance
- Scratch resistance

Halar[®]

- Very good resistance to chemicals, solvents and hydrofluoric acid (HF)
- Good mechanical properties
- Diffusion barrier
- Non-flammable
- High disruptive strength
- Very good resistance to weathering
- Colour: dark grey-olive

Amkophen F12[®] | Zacosin 2012[®]

- Thermosetting duroplast
- Basis: Phenol-formaldehyde resin
- Chemical resistance: pH range 1 – 8
- Colour: dark green

VHE 109[®] | Chemonit 31[®] hard rubber coating

- Long-term chemical resistance and impermeability
- Long-term thermal resistance
- Long-term mechanical load-bearing capacity
- Very good adhesion to the substrate
- Colour: reddish brown

From design to customer



Fan selection with
own software

project reference	
customer :	HF ref. :
customer's ref. :	position :
commission :	HF-type : HF R 1250-13 D (DS2)

Hürner Luft- und Umwelttechnik

**HF - radial fan direct driven
in efficiency optimized premium version „blue Hfan“**

Corrosion resistant plastic radial fan with housing in thermoplastics, in welded version, one inlet side, condensate drainage at the lowest point of the housing, splinter protection according to accident prevention rules as plastic coated wire mesh, inspection opening on the inlet side, Shaft passage with Kera/Viton-seal as standard. Impeller with backward curved blades, statically and dynamically balanced, quality of balancing at least G 6.3 (DIN ISO 21940-11), floating-mounted on the motor shaft.
Fan frame in strong, welded steel construction, galvanised version, with motor support plate, suitable for fan housing with impeller and motor.

make	: Hürner Luft - und Umwelttechnik
type	: HF R 1250-13 D (DS2)

Housing-material	: PP-FR
Impeller-material	: FRP
housing position	: GR 360
inlet diameter	: 1250 mm
discharge medium	: air
ambient pressure	: 101,325 kPa
medium temperature	: 20 °C
density of medium suction side	: 1,169 kg/m ³

volume flow	: 100000 m ³ /h
total pressure difference	: 3309 Pa
static pressure difference	: 3000 Pa
operating speed	: 926 1/min
max. speed impeller	: 940 1/min
admissible range of medium temp.	: 0 / 70 °C
fan control (on site)	: frequency converter
operating frequency	: 47,2 Hz
flow-velocity	: 24,2 m/s
circumferential speed	: 78,8 m/s
sound pressure level Lp2A (1 m)	: 85 dB(A)
sound pressure level Lp2A (1 m)*	: - dB(A)
sound power level Lw6A	: 110 dB(A)
impeller efficiency	: 80,7 %
SFP (specific fan power)	: 4250 [8] W/(m ³ /s)
power requirements at the shaft	: 112,63 kW

motor power	: 132 kW
speed motor	: 980 1/min
voltage	: 3~ 400/690 V
power freq.	: 50 Hz
rated current	: 224,4 A
mounting/size	: IM B3, KK OBEN / 315L
Enclosure/motor protection	: IP 55/PTC
Ex classification	: -
motor suitable for VFD	: yes
addition	: -
motor efficiency	: IE3

Sound values without consideration of the motor *with motor for power frequency
Subject to technical changes!

date: 06.06.2019
internal ID:
V 1.1.9 4608 05 2613

 <small>Hürner Luft- und Umwelttechnik</small>	Hürner Luft- und Umwelttechnik GmbH Ernst-Hürner-Strasse 35325 Mücke-Atzenhain Germany	Fon: +49 (0) 64 01/91 80-0 Fax: +49 (0) 64 01/91 80-142 info@hlu.eu www.hlu.eu
--	--	---

Fan drawing

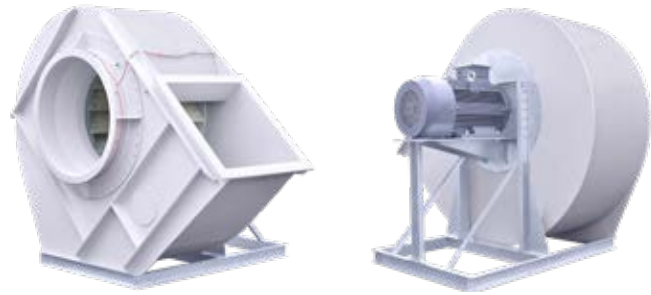

Fan drawing (2D)

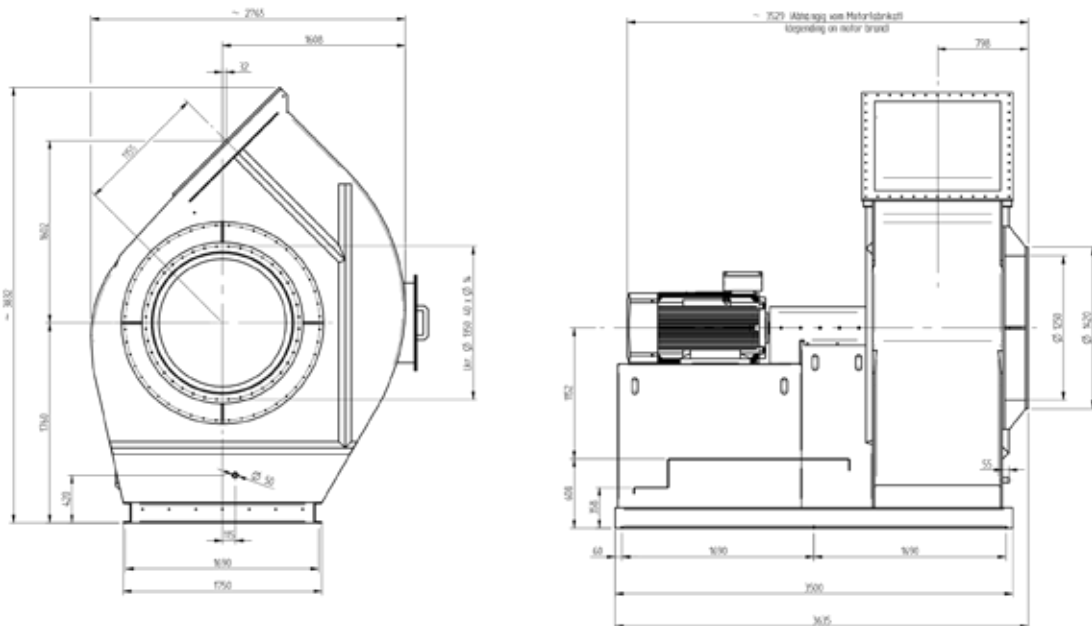

Fan drawing (3D)

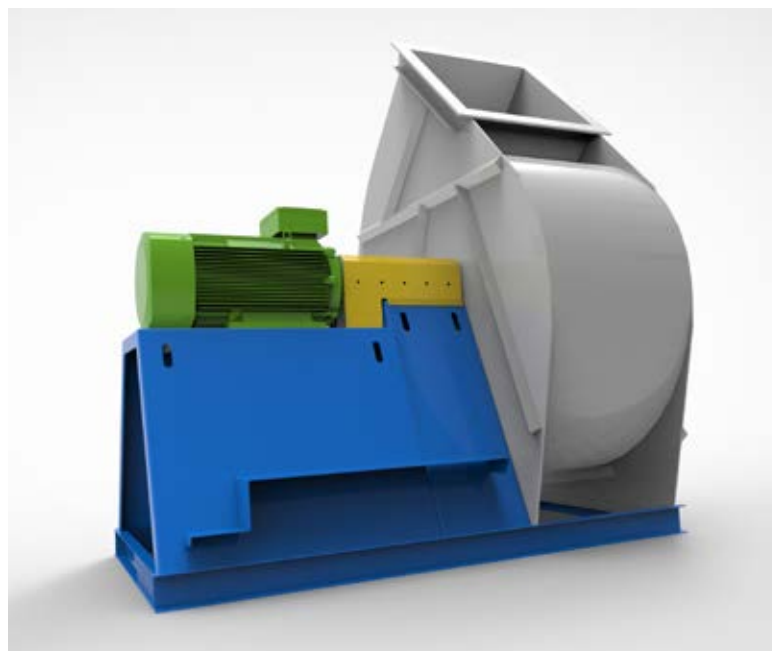



Customer installation



ATEX 2014/34/EU



Shaft
Kera/Viton
P. 33

Shaft seal
Hastelloy/Viton
P. 33

Protection grid
P. 32

HLU fans according to ATEX 2014/34/EU

The ATEX Directive 2014/34/EU regulates the requirements with regard to placing products on the market that are used in potentially explosive atmospheres. The term ATEX is derived from the French abbreviation "Atmosphère explosible" and is used as a synonym for the two directives of the

European Community in the area of explosion protection, ATEX Directive 2014/34/EU and ATEX Directive 1999/92/EG. The design of fans in the ATEX area is described in detail in the norms DIN EN 14986 and DIN EN ISO 80079.

Explosion protection is differentiated according to the conveyed atmosphere (inside) and the surroundings of the installation site (outside).

HLU supplies fans for the ATEX Zones 2 and 1 for different zone combinations.

inside	outside
Zone 1	Zone 1
Zone 1	Zone 2
Zone 2	Zone 2
Zone 2	no Zone

HF - centrifugal fan in ATEX version – for Zone 2 inside / no Zone outside:

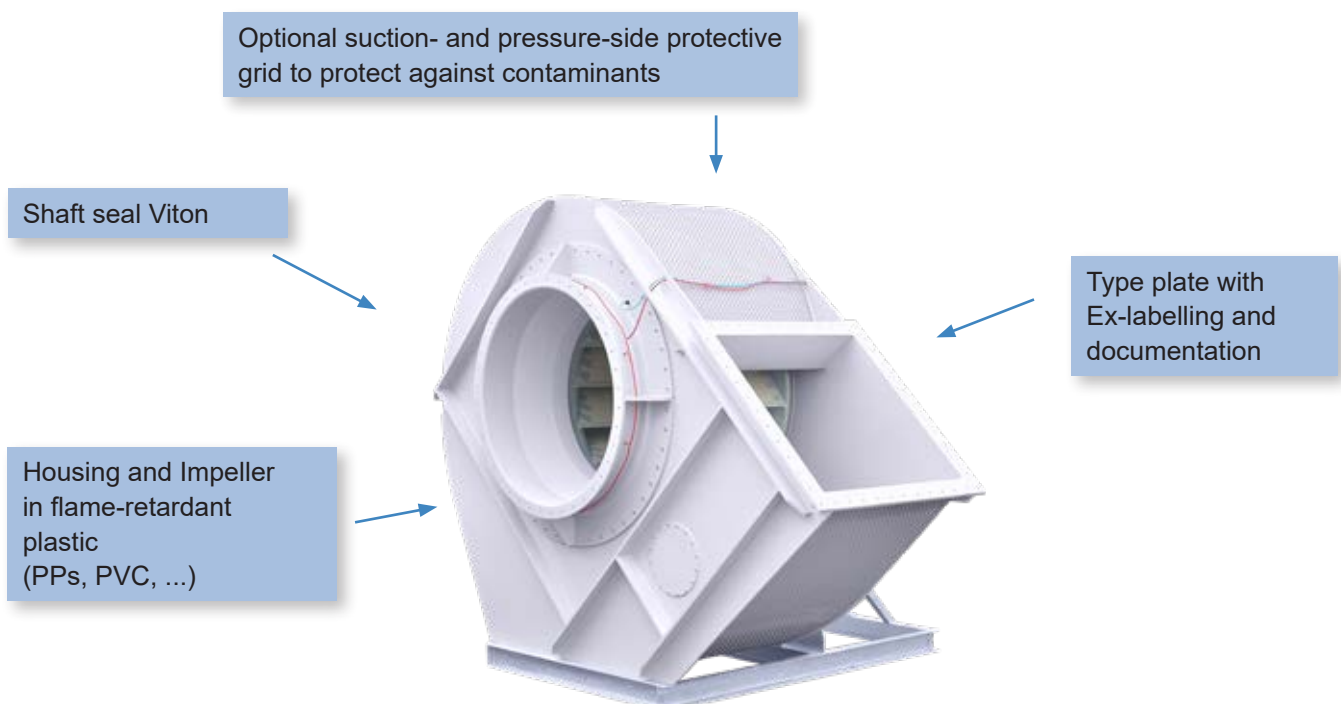

HF -centrifugal fan in ATEX version – for Zone 2 inside / Zone 2 outside:

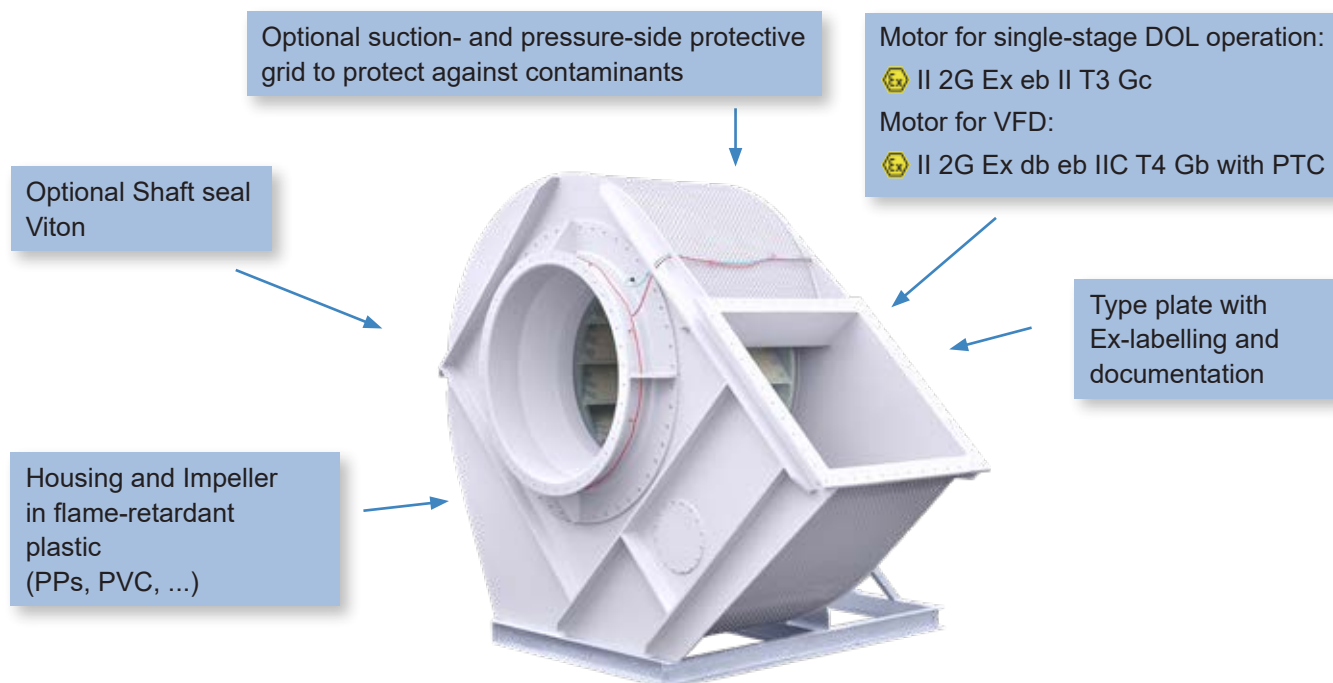

HF -centrifugal fan in ATEX version – for Zone 1 inside / Zone 2 outside: – for Zone 1 inside / Zone 1 outside:

HLU fans for ATEX Zone 1 are made of electrical conductive plastics (el).

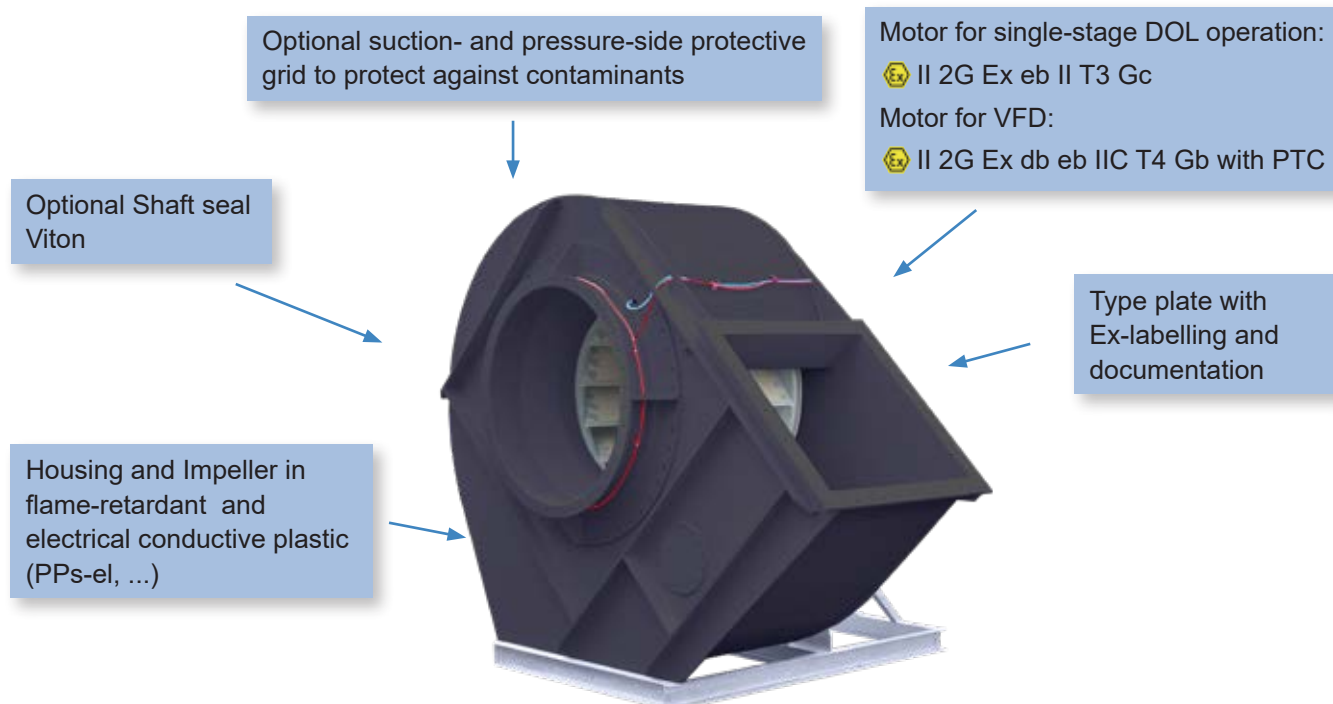

ATEX 2014/34/EU



You will see on the fan's type plate a permanent identification of the explosion protection. The following illustration explains the labelling of equipment for potentially explosive atmospheres:

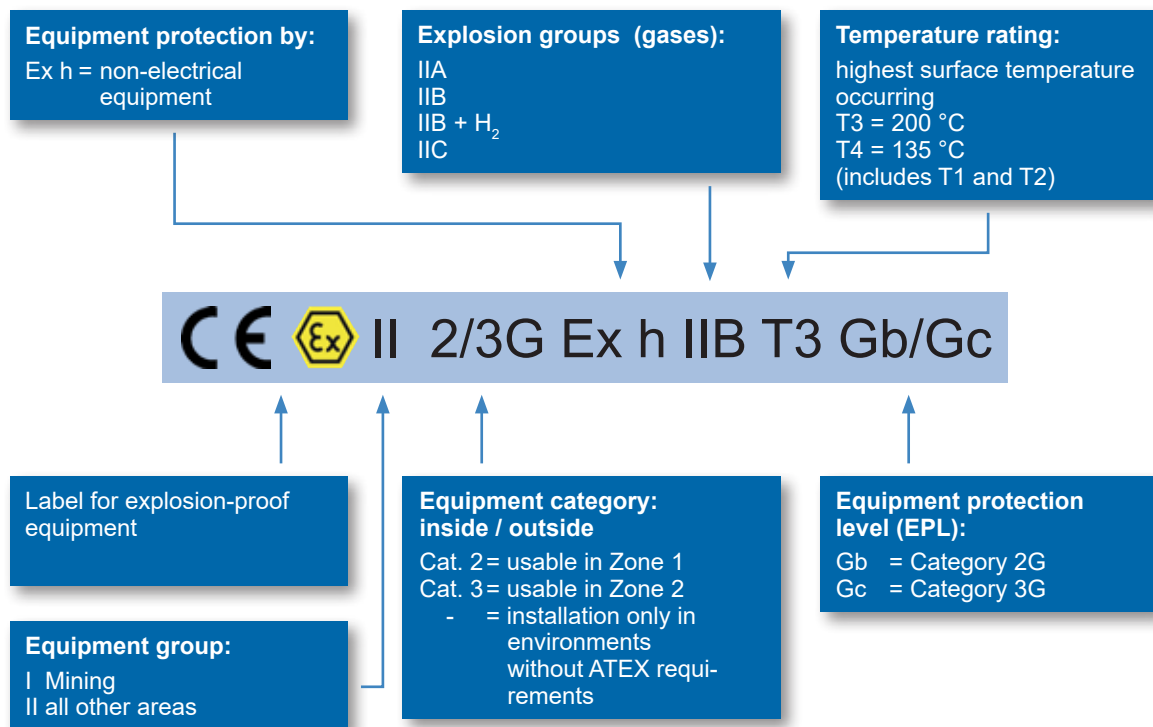

The operator of a facility is obligated to conduct a risk assessment. For questions regarding the Zone classification, you can contact various test centres such as for example safety engineers and special consultants. The following tables serve as reference:

An explosive gas atmosphere exists ...	ATEX Ex Zone	ATEX Device category	IEC EPL	(International) (Equipment Protection Level)
for more than 30 min. per year, however, less than 50% of the operational period daily	Zone 1	Category 2G		Gb
for a max. of 30 min. in a year	Zone 2	Category 3G		Gc

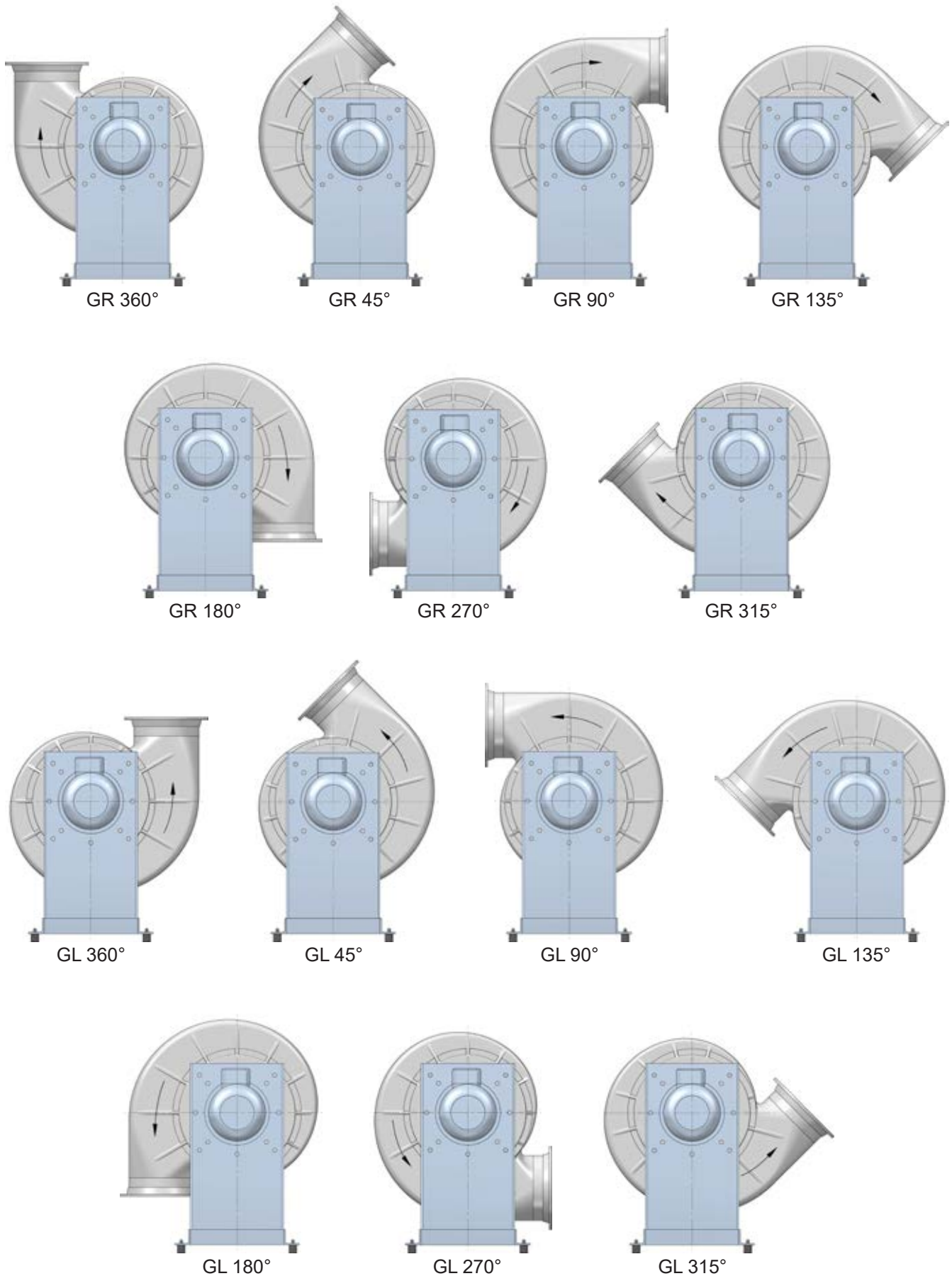

www.hlu.eu

Hürner Luft- und Umwelttechnik GmbH

Ernst-Hürner-Straße
35325 Mücke-Atzenhain
Germany

Tel. +49 6401 9180 - 0
Fax +49 6401 9180 - 142

info@hlu.eu

